

# MONOGRAPHY



**006 LIVING**

007 ALAYA ASIX sofa  
013 ALAYA central table  
012 ALAYA console  
011 ALAYA courtesy table  
020 ALAYA modular sofa  
026 ALAYA side element low corner  
027 ALAYA side element high dormeuse  
031 ALLURE central table  
055 ALLURE side table  
022 ANTIBES central table marble top  
087 ANTIBES central table  
025 ARAMIS armchair  
037 ATRIUM modular sofa  
051 ATRIUM sofa

083 COLINE sofa

059 GALA desk

045 JEAN armchair

075 LOUISE sofa

033 MEZZALUNA console  
041 MONTREAL backsofa console  
057 MONTREAL bookshelf  
056 MONTREAL console

069 NUAGE tv cabinet

042 PETITE side table

071 REFLECT mirror

047 SEGMENTI wall decoration  
088 SOL side table  
088 SOL sofa table  
089 SOL sofa table composition

081 TRUFFLE sofa table  
015 TWILLY armchair

061 VAGUE armchair  
065 VAGUE sofa

**092 DINING**

107 ANTIBES table base, DOMINO table top

120 CARTESIO table base, ORIGAMI table top

124 CARTESIO table base, MIKADO table top

128 CLAIRE chair

117 HYDE PARK wall decoration

110 MAXIME chair

099 MAXIME SOFT chair

115 MEMORIES display cabinet

103 MEZZALUNA table base, ORIGAMI table top

097 MEZZALUNA table base, SEGMENTI table top

112 NUAGE sideboard

104 TWILLY chair

092 TWILLY chair with arms

**132 SLEEPING**

147 ALLURE mirror

137 ANTIBES chest of drawers

137 ANTIBES night table

139 ASTORIA bed

153 CHELSEA bed

143 HYDE PARK bed

156 MAGIC chest of drawers

161 MAGIC dressing

162 MAGIC highboy

159 MAGIC night table

169 NOMAD rug

133 SOHO bed

166 TAMBOUR rug

WELCOME TO THE SENSUAL HOME OF MONOGRAPHY,  
WHICH CONVEYS AN UNUSUAL TYPE OF BEAUTY,  
DEEPLY REFINED AND ELEGANTLY SEDUCTIVE. A UNIVERSE  
WHERE RATIONALISTIC AESTHETICS MELD WITH TIMELESS  
DESIGN INSPIRATIONS, THANKS TO ALCHEMICAL  
PROPORTIONS AND UNUSUAL MATERIALITY.



**THE LIVING AREA OF MONOGRAPHY EPITOMIZES CONTEMPORARY SOPHISTICATION AND SUBTLE REFINEMENT IN EVERY PIECE OF FURNITURE. CLEAN LINES, EXQUISITE MATERIALS BECOME THE HALLMARK OF MINIMALIST DESIGN: A LIBERATED AESTHETIC THAT ALLOWS MONOGRAPHY PIECES TO SEAMLESSLY INTEGRATE INTO THE MOST DIVERSE ENVIRONMENTS. LET'S EXPLORE THE SPACES WE INHABIT AND CREATE REFINED FURNISHINGS TO MAKE THEM TRULY UNIQUE.**

Technical info → P.172

ALAYA ASIX 4 SEATS, ALAYA COURTESY TABLE, ALAYA CENTRAL TABLE, JEAN ARMCHAIR, TWILLY ARMCHAIR, TAMBOUR RUG





ALAYA ASIX 4 SEATS, ALAYA COURTESY TABLE



ALAYA COURTESY TABLE



ALAYA CONSOLLE



ALAYA CENTRAL TABLE







ALAYA COURTESY TABLE



ALAYA CONSOLLE



TWILLY ARMCHAIR

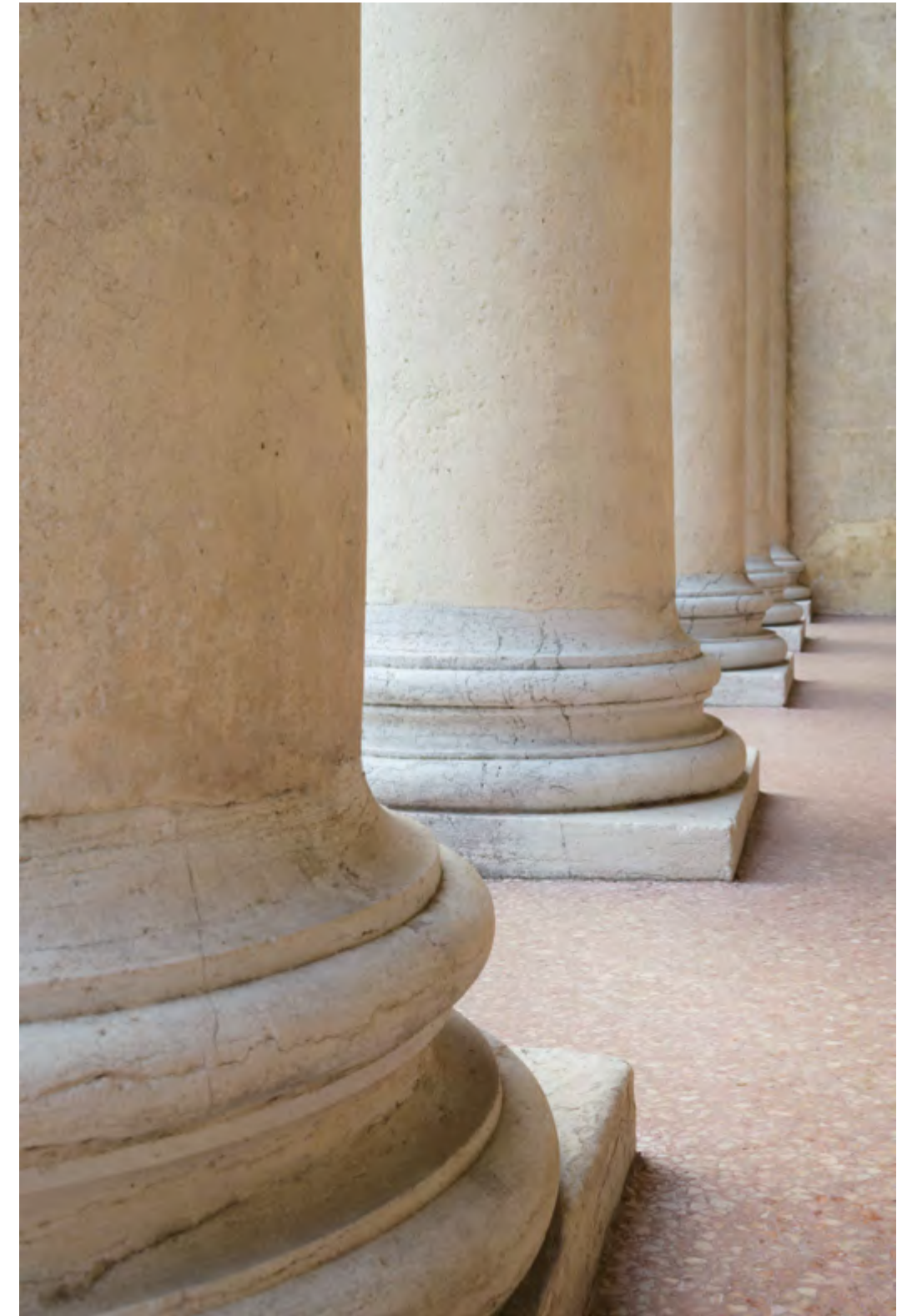





ANTIBES CENTRAL TABLE LARGE, ANTIBES CENTRAL TABLE SMALL



ALAYA MODULAR SOFA, ANTIBES CENTRAL TABLE LARGE



ALAYA SIDE ELEMENT LOW CORNER, ALAYA SIDE ELEMENT HIGH DORMEUSE, ALLURE CENTRAL TABLE CIRCULAR, ALLURE SIDE TABLE







ALLURE CENTRAL TABLE CIRCULAR





MEZZALUNA CONSOLLE

**EXPERIENTIAL VOLUMES MERGE WITH STYLISTIC FUNCTIONALITY. THESE ARE THE DISTINCTIVE TRAITS OF THE NEW MONOGRAPHY FURNISHINGS. UNIQUE PIECES CHARACTERIZED BY THE DISTINCTIVE TRAITS OF MINIMALIST AND TIMELESS ELEGANCE: THE IDEAL PRODUCTS TO ENRICH LIVING SPACES WITH AN UNEXPECTED TOUCH OF MODERNISM.**



ATRIUM MODULAR SOFA, PETITE SIDE TABLE, ANTIBES CENTRAL TABLE SMALL





ATRIUM MODULAR SOFA





MONTREAL BACKSOFA CONSOLLE





PETITE SIDE TABLE



JEAN ARMCHAIR



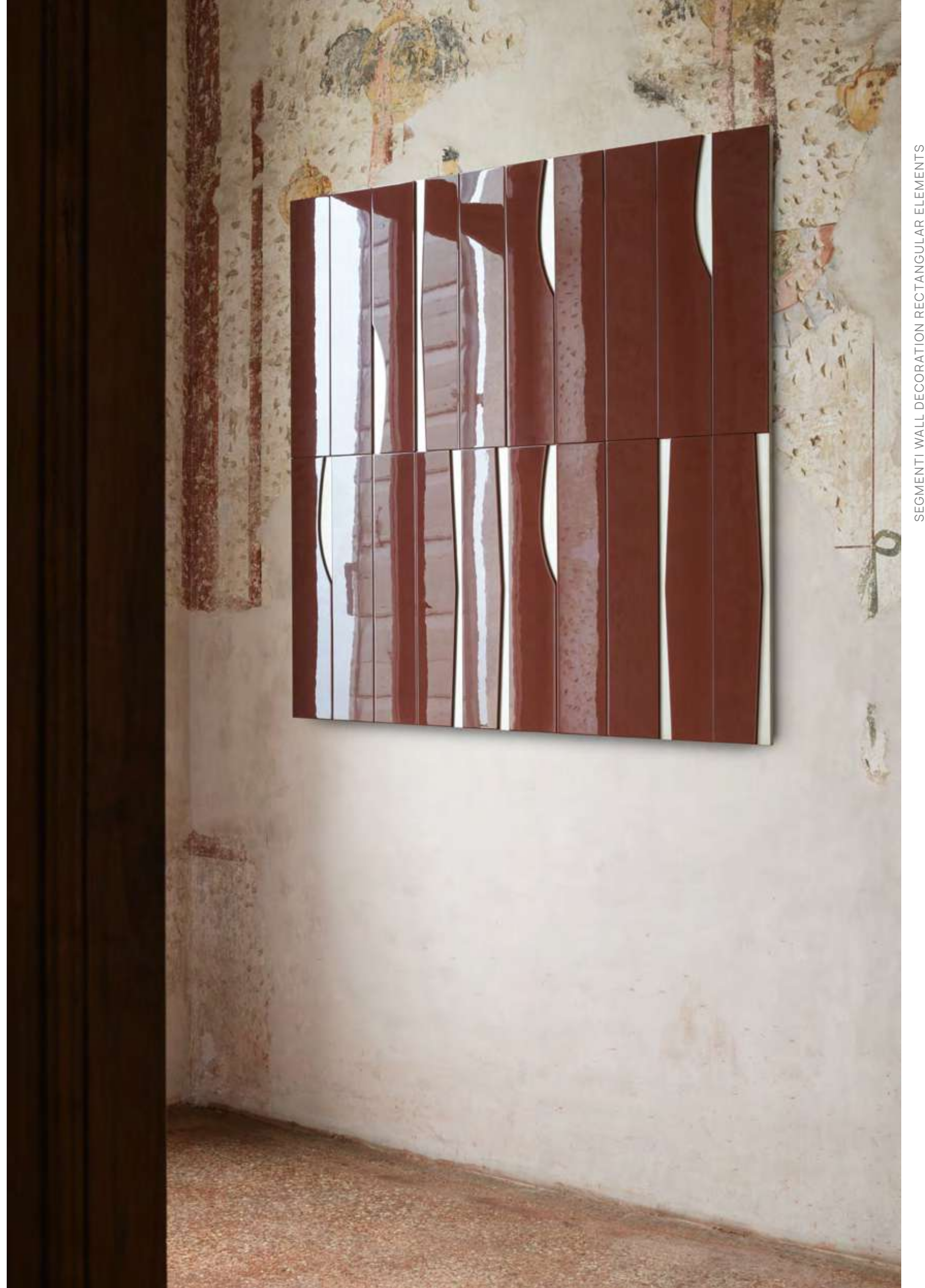

SEGMENTI WALL DECORATION RECTANGULAR ELEMENTS







ATRIUM SOFA 4 SEATS







ALLURE SIDE TABLE

MONTREAL CONSOLLE



MONTREAL BOOKSHELF DOUBLE 150+120





GALA DESK, TWILLY CHAIR

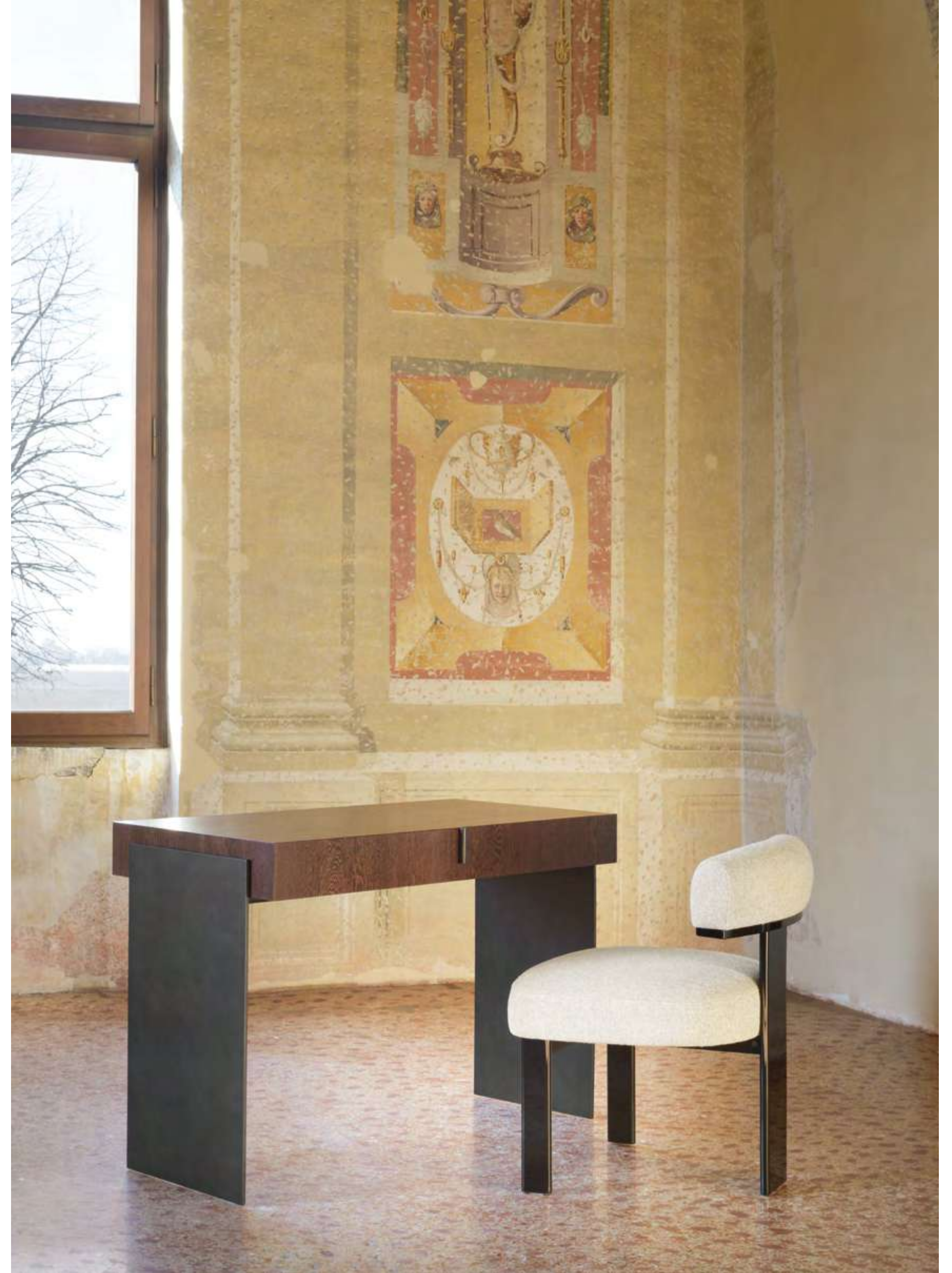

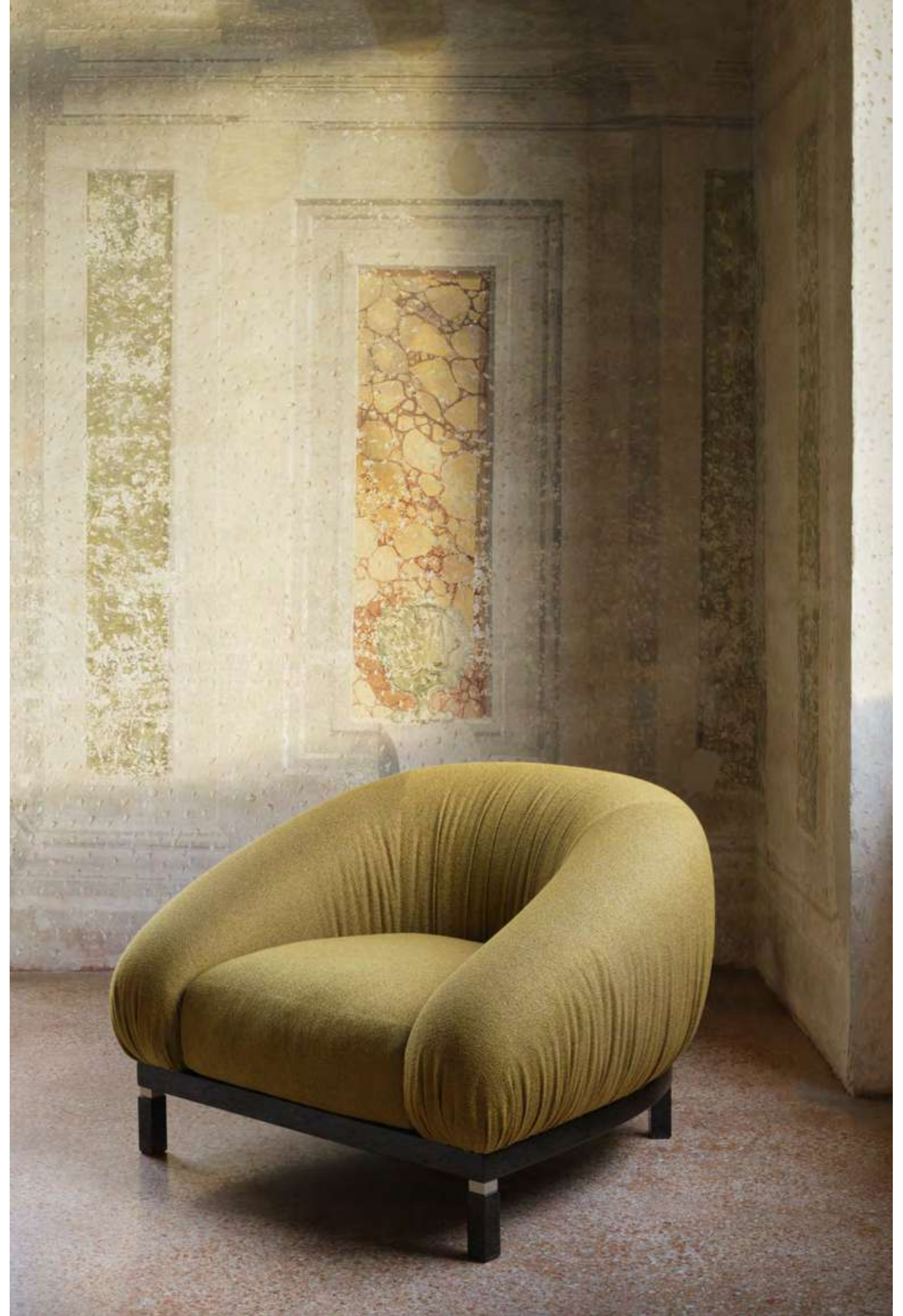

VAGUE ARMCHAIR









VAGUE ARMCHAIR



NUAGE TV CABINET





REFLECT RECTANGULAR MIRROR, REFLECT SQUARE MIRROR

**THE COMMITMENT TO EXCELLENCE IS AT THE HEART OF OUR PRODUCTION, EMBODIED BY UNIQUE, HANDMADE FURNISHINGS. DELVE INTO THE UNIVERSE OF MONOGRAPHY TO DISCOVER A WIDE SELECTION OF FINE FURNITURE CRAFTED WITH CARE AND DEDICATION. EACH PIECE IS A WORK OF ART THAT EXUDES A SENSE OF PRIVATE LUXURY AND SOPHISTICATION.**



LOUISE SOFA 4 SEATS, TRUFFLE 120 SOFA TABLE, TRUFFLE 45 SOFA TABLE, ARAMIS ARMCHAIR, TAMBOUR RUG





LOUISE SOFA 4 SEATS

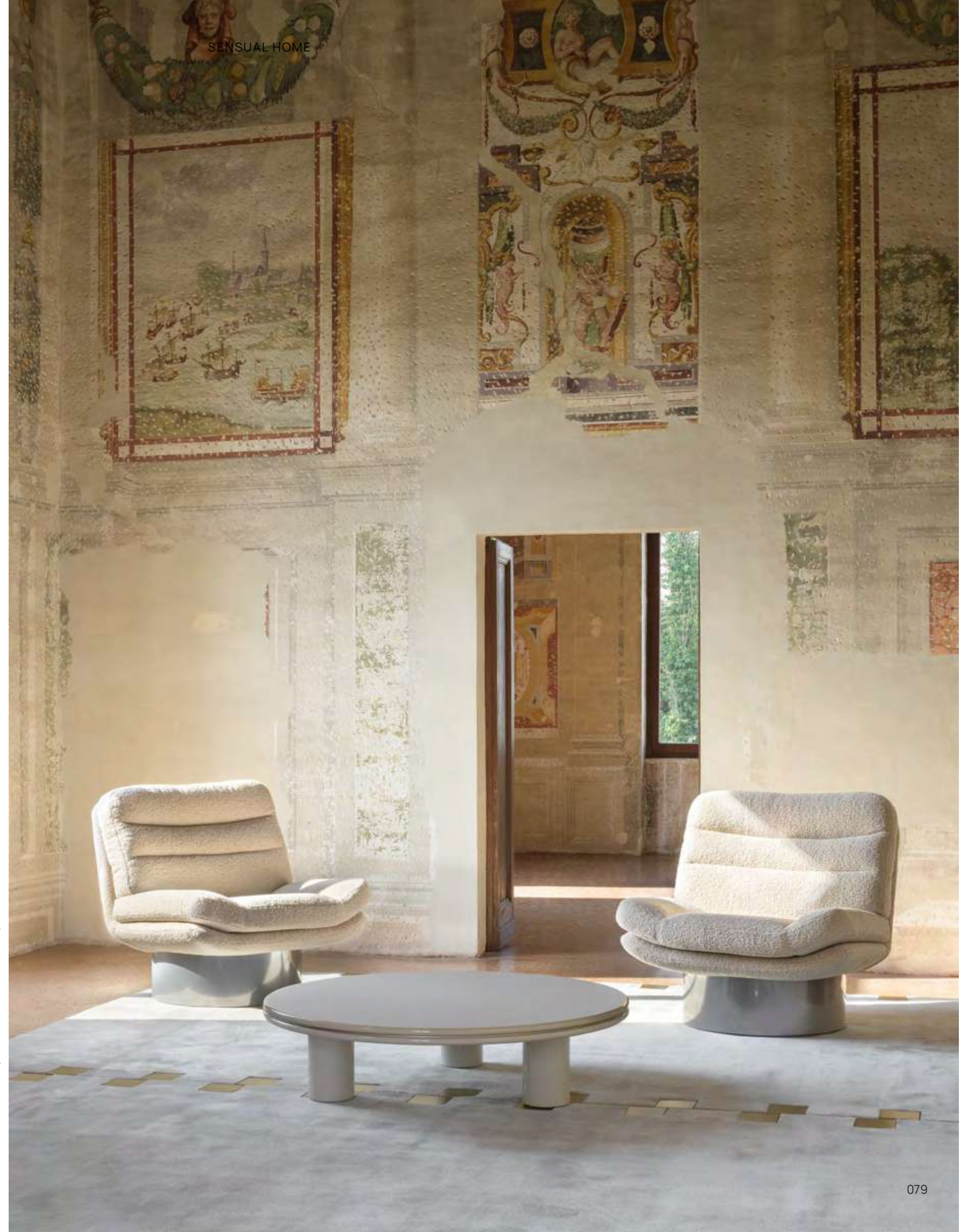
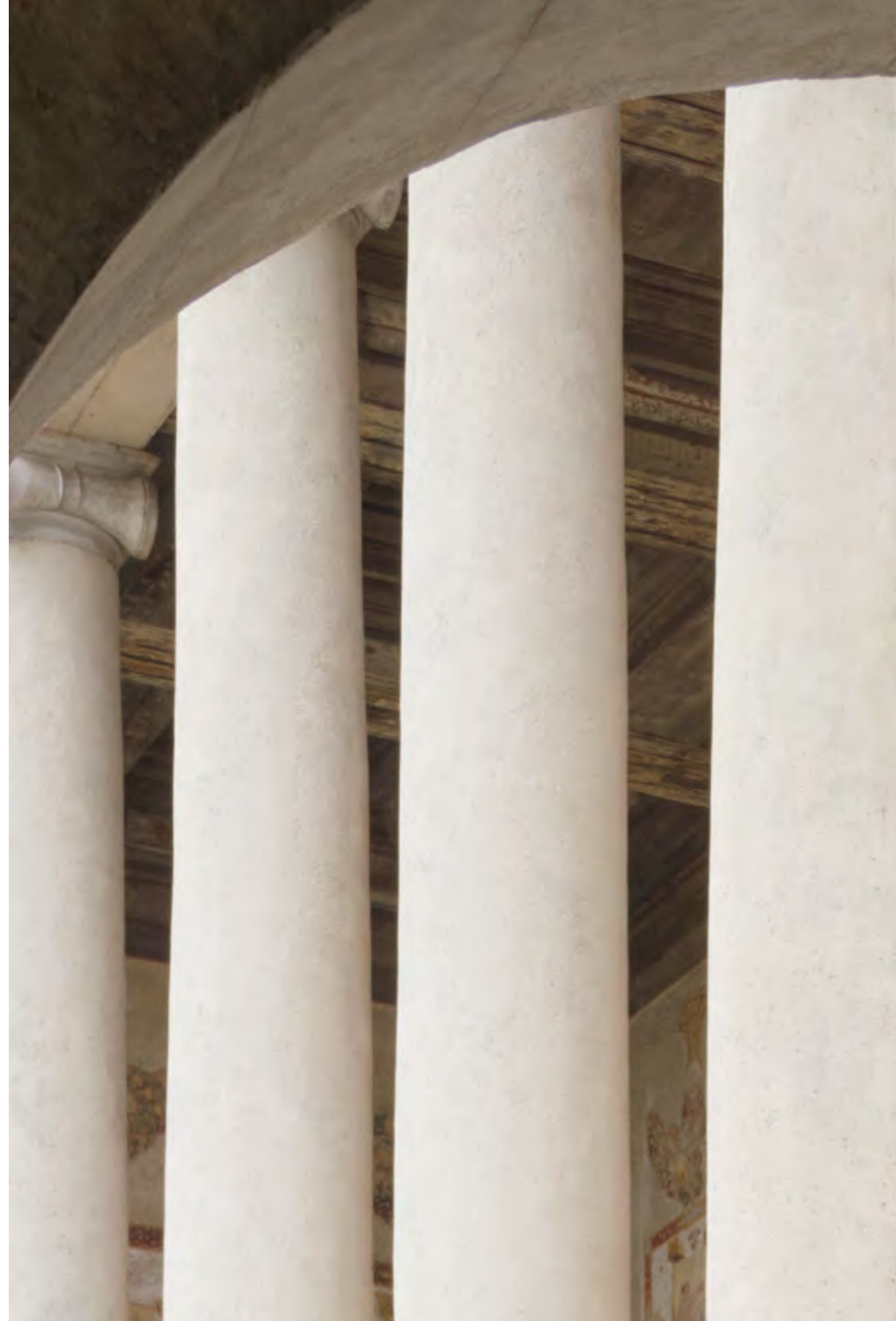

TRUFFLE 120 SOFA TABLE, ARAMIS ARMCHAIR, TAMBOUR RUG





TRUFFLE 120 SOFA TABLE, TRUFFLE 80 SOFA TABLE, TRUFFLE 45 SOFA TABLE

COLINE SOFA 4 SEATS, VAGUE ARMCHAIR, ANTIBES CENTRAL TABLE LARGE, ANTIBES CENTRAL TABLE SMALL, TAMBOUR RUG





SENSUAL HOME

COLINE SOFA 4 SEATS



ANTIBES CENTRAL TABLE SMALL

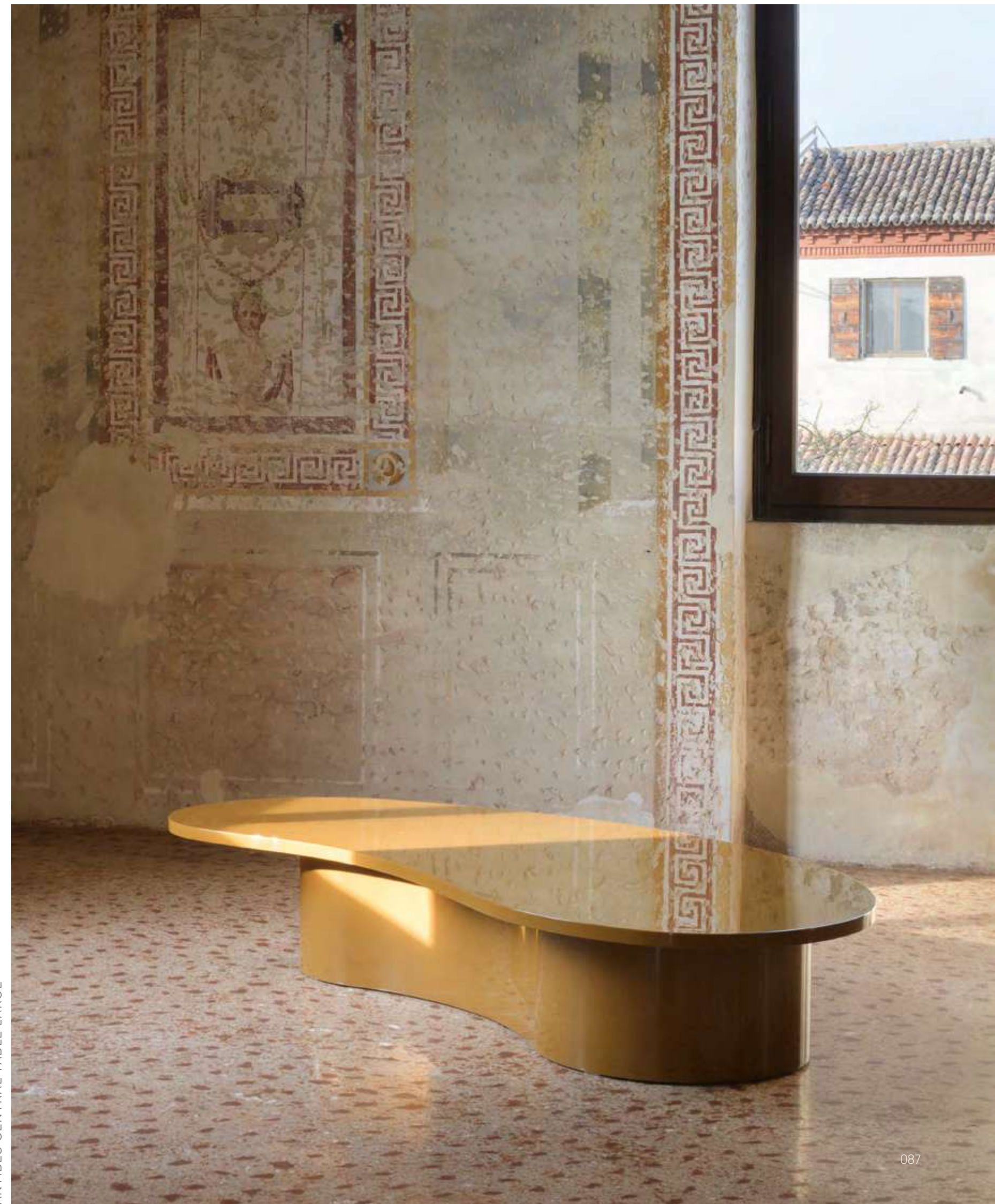

ANTIBES CENTRAL TABLE LARGE



SOL SIDE TABLE, SOL SOFA TABLE



VAGUE ARMCHAIR, SOL SOFA TABLE COMPOSITION

RELYING ON A VISION OF ETERNAL ELEGANCE AND RATIONALISM, MONOGRAPHY SHAPES MATERIALS TO ENHANCE THEIR QUALITIES, CREATING FURNISHINGS THAT ARE AESTHETICALLY PLEASING AS WELL AS FUNCTIONAL OVER TIME. OUR FOCUS ON THE EMOTIONAL ALCHEMY OF DESIGN IS REFLECTED IN THE METICULOUS SEARCH FOR PREMIUM MATERIALS.



TWILLY CHAIR WITH ARMS

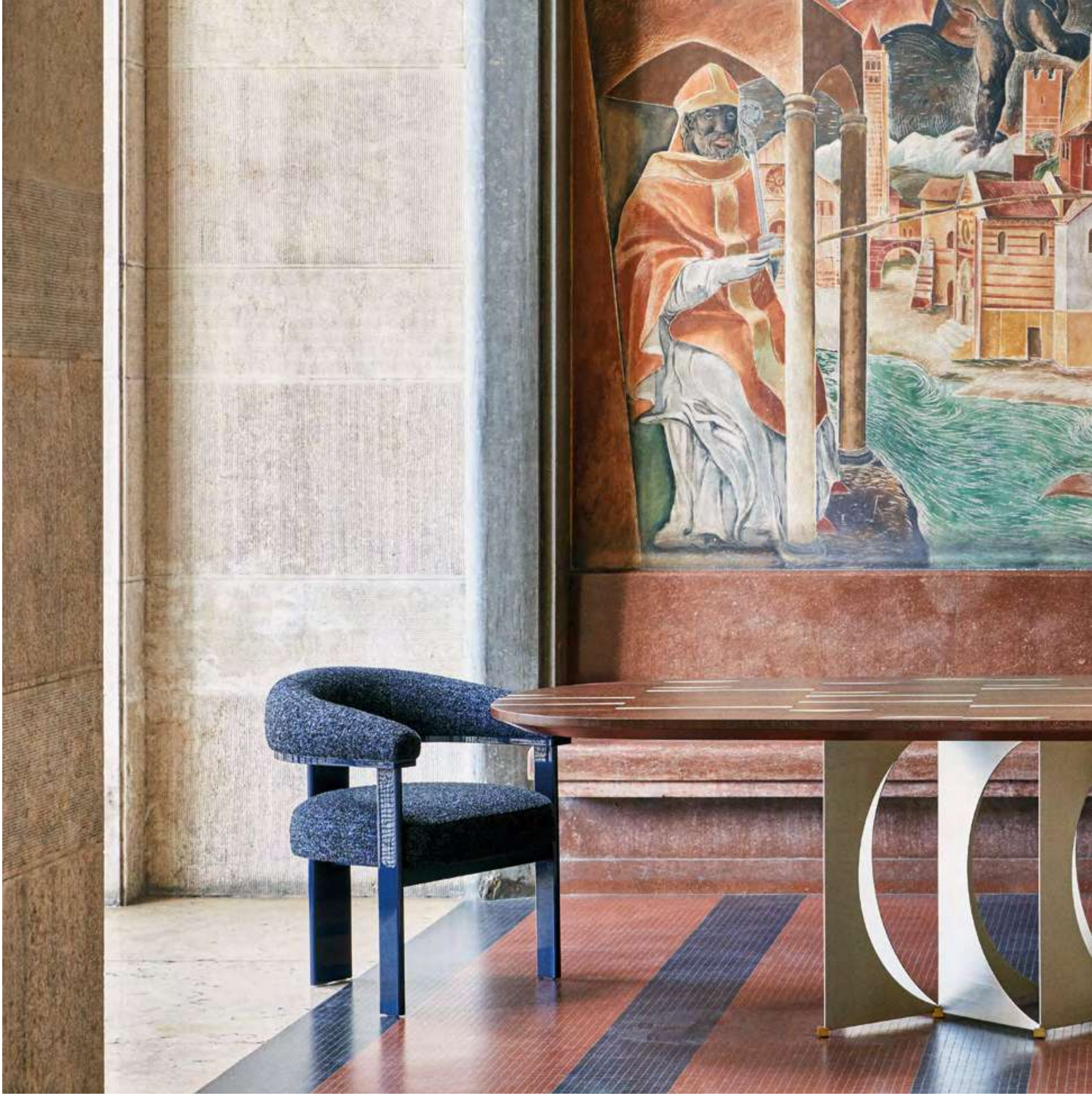

SEGMENTI OVAL TOP





TWILLY CHAIR WITH ARMS



MEZZALUNA BASE FOR OVAL TOP, SEGMENTI TOP FOR OVAL TABLE 300, MAXIME SOFT CHAIR



**EACH MONOGRAPHY PIECE FOR THE DINING AREA REFLECTS A CONTEMPORARY ELEGANCE THAT FOSTERS A CONVIVIAL ATMOSPHERE. THE SOPHISTICATION OF THE FORMS MERGES WITH THE SELECTION OF REFINED MATERIALS TO CREATE AN EMOTION OF HARMONIOUS COHERENCE. ELEGANTLY ESSENTIAL, MONOGRAPHY PIECES ARE DESIGNED TO BE LIVED EVERY DAY AND TO BE ADMIRER.**

Technical info → P.172



MAXIME SOFT CHAIR





MAXIME SOFT CHAIR







TWILLY CHAIR







DOMINO TOP FOR ROUND TABLE 160



MAXIME CHAIR



MAXIME CHAIR





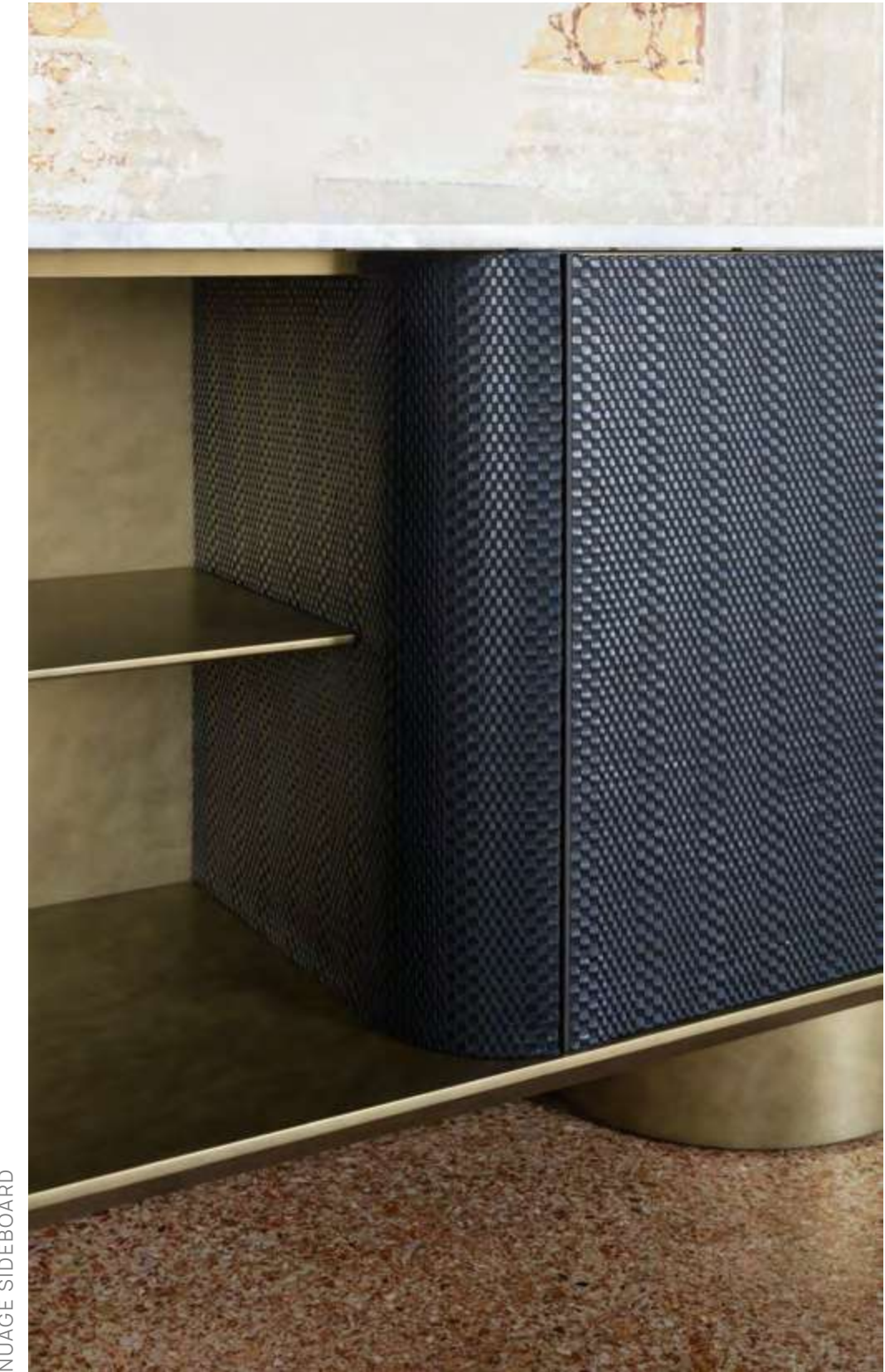

NUAGE SIDEBOARD

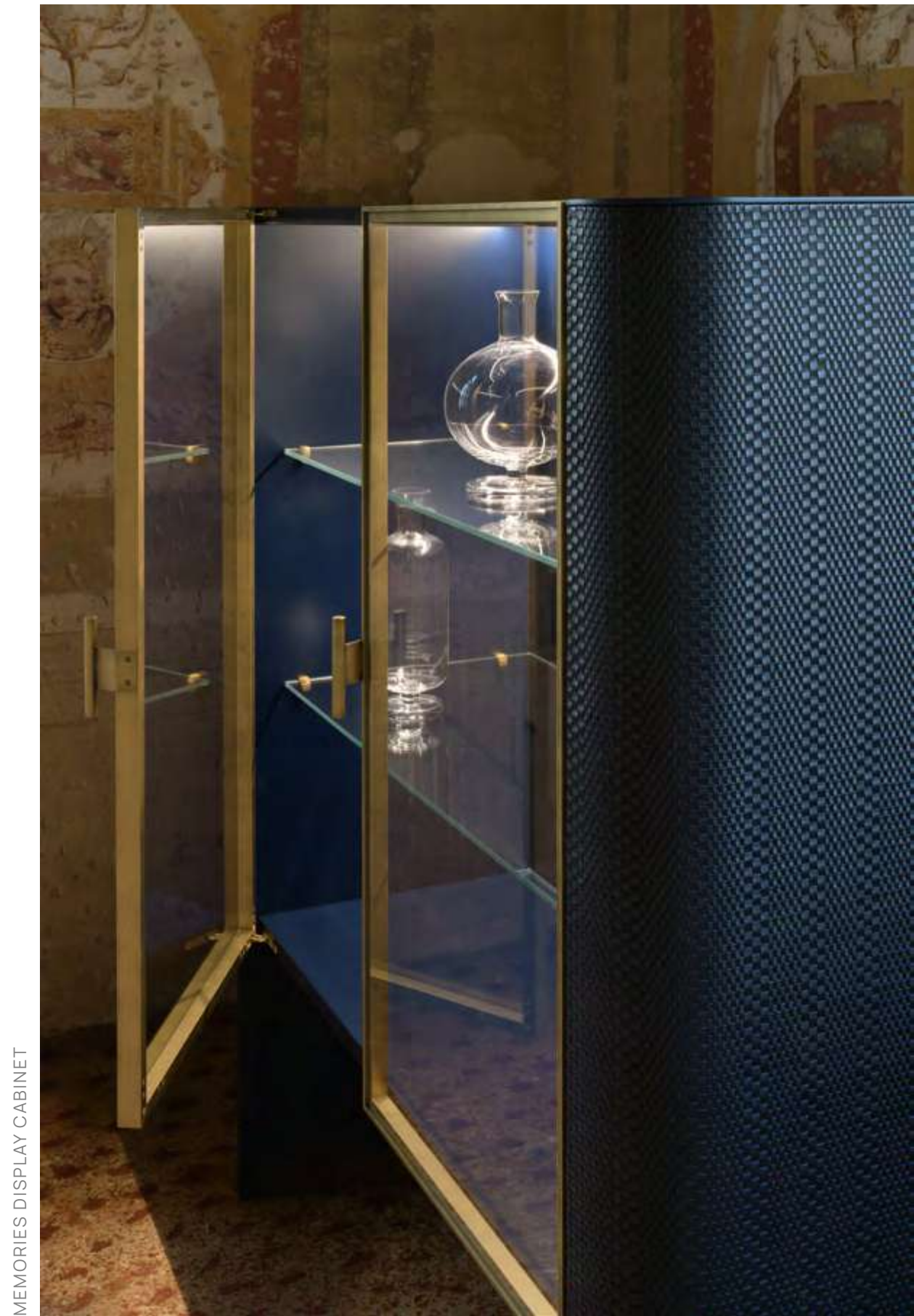

MEMORIES DISPLAY CABINET

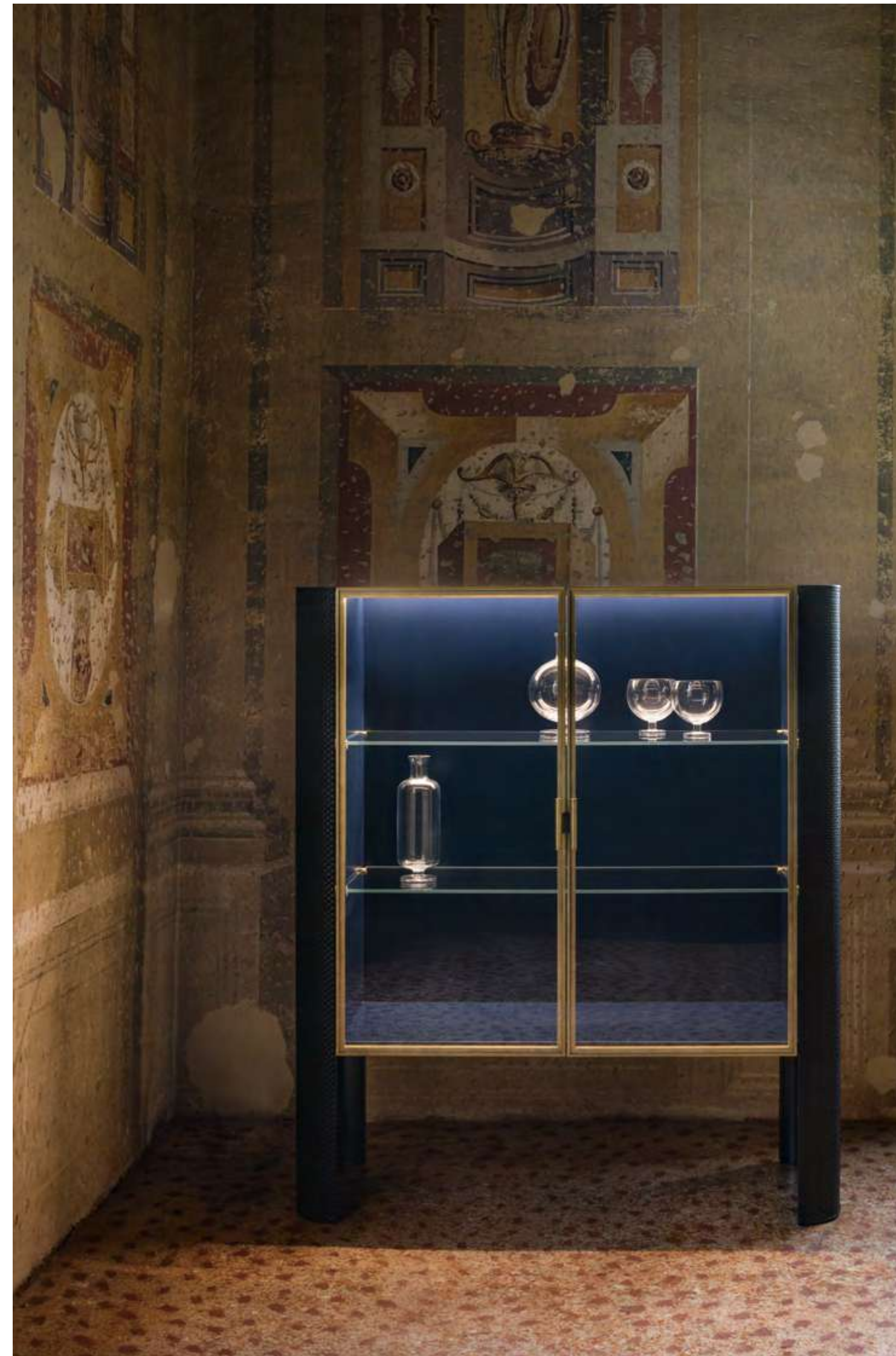



HIDE PARK WALL DECORATION

**THE EMBODIMENT OF TIMELESS BEAUTY REFLECTS AN IMPRINT THAT COMMUNICATES REFINED CONTEMPORANEITY. OUR PIECES ARE ELEGANTLY SIMPLE AND DESIGNED TO CREATE AN ATMOSPHERE OF EVERYDAY SOPHISTICATION. OUR COLLECTION INCLUDES ESSENTIAL ELEMENTS OF INTERIOR DESIGN, INTENDED TO FURNISH BOTH HOME AND OFFICE SPACES WITH FUNCTIONALITY AND STYLE.**







CARTESIO BASE FOR OVAL TOP, ORIGAMI OVAL TOP





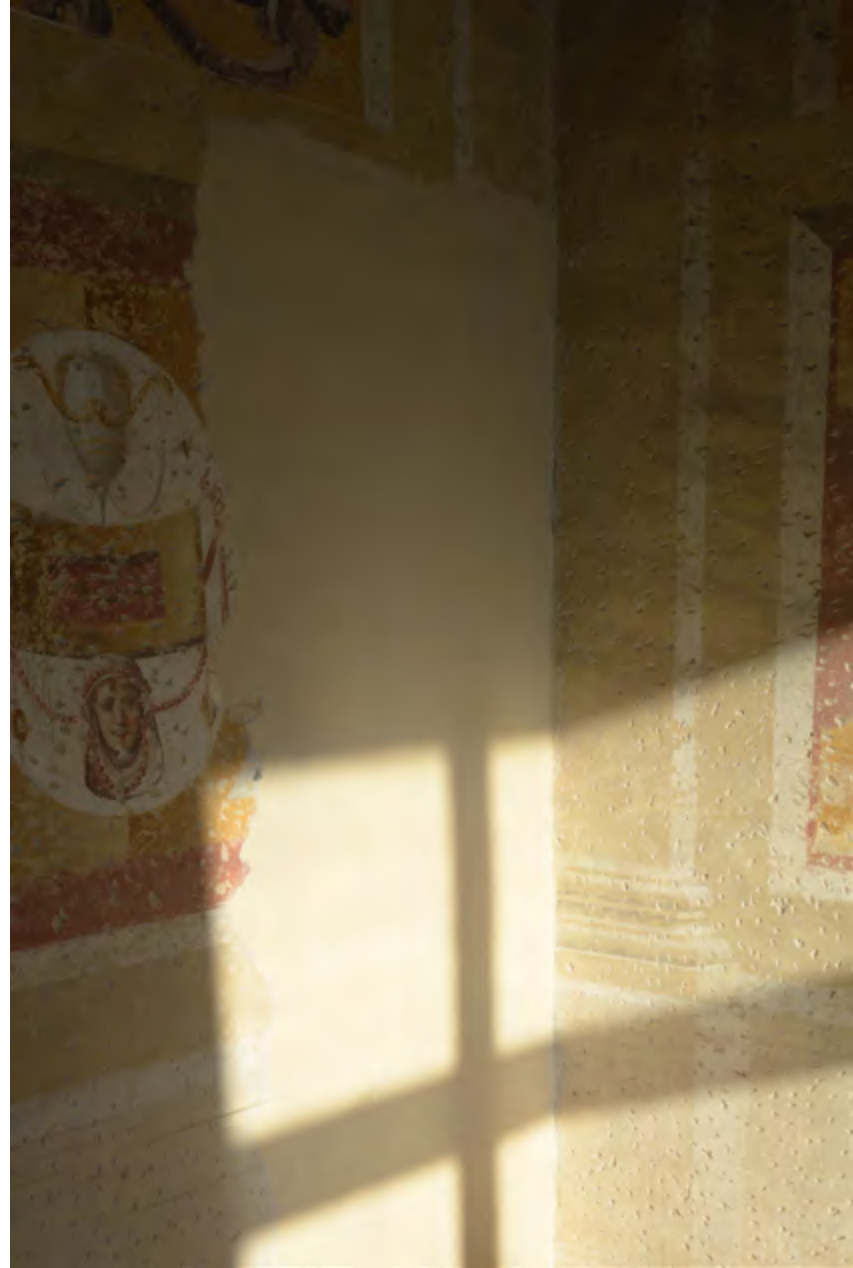

MIKADO ROUND TOP





CLAIRE CHAIR



A SENSE OF REFINED LUXURY IS PORTRAYED THROUGH THE CREATION OF AN ATMOSPHERE THAT COMBINES FUNCTIONALITY WITH THE HARMONY OF STYLE. THE LINES AND SHAPES OF THE NEW MONOGRAPHY COLLECTION REFLECT A SOFT AND ENVELOPING VISION OF CURRENT DESIGN, CAPABLE OF BESTOWING A TOUCH OF CONTEMPORARY SENSUALITY TO ANY SPACE.





**FOR MONOGRAPHY, THE SLEEPING AREA IS THE REPRESENTATION OF AN EMOTIONAL ALCHEMY, GIVING LIFE TO UNIQUE FURNISHINGS THAT CONVEY RELAXING SENSATIONS AND CREATE ETHEREAL ATMOSPHERES. THE REFLECTION OF A PERSONAL LIFESTYLE THROUGH REFINED DESIGN RIGOR AND PRODUCTION EXCELLENCE. AS IN A DREAM WORKSHOP, THE PRODUCTS EVOKE NOSTALGIA AND ROMANTICISM, EXPERIMENTING WITH MATERIALS, TECHNIQUES, AND FABRICS TO OUTLINE THE MOST SEDUCTIVE IDEAS.**

Technical info → P.172



ANTIBES NIGHT TABLE



SOHO BED



ASTORIA BED QUEEN SIZE, ANTIBES NIGHT TABLE, TWILLY ARMCHAIR





ANTIBES CHEST OF DRAWERS

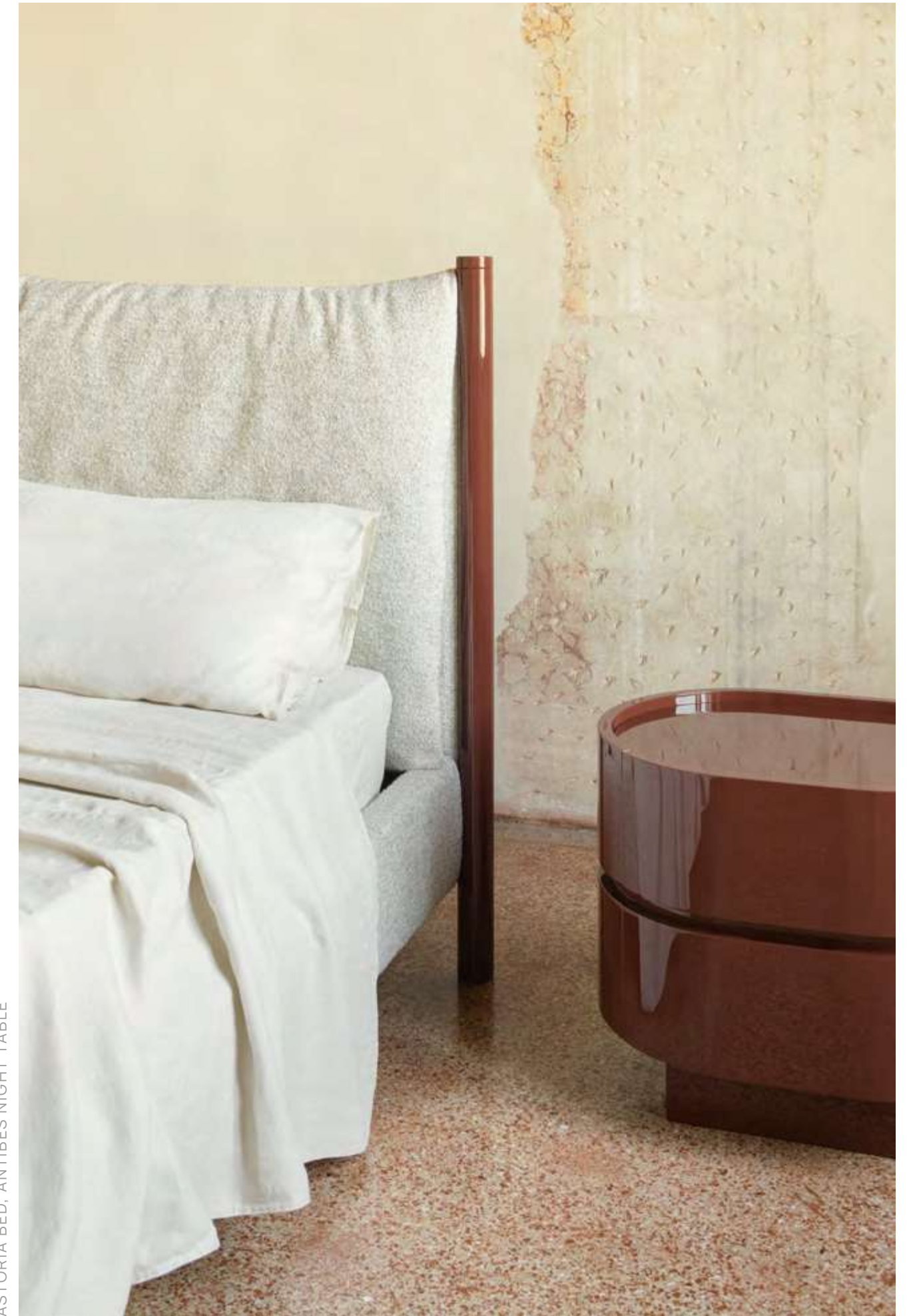

ASTORIA BED, ANTIBES NIGHT TABLE

HYDE PARK BED QUEEN SIZE, ANTIBES NIGHT TABLE







HYDE PARK BED



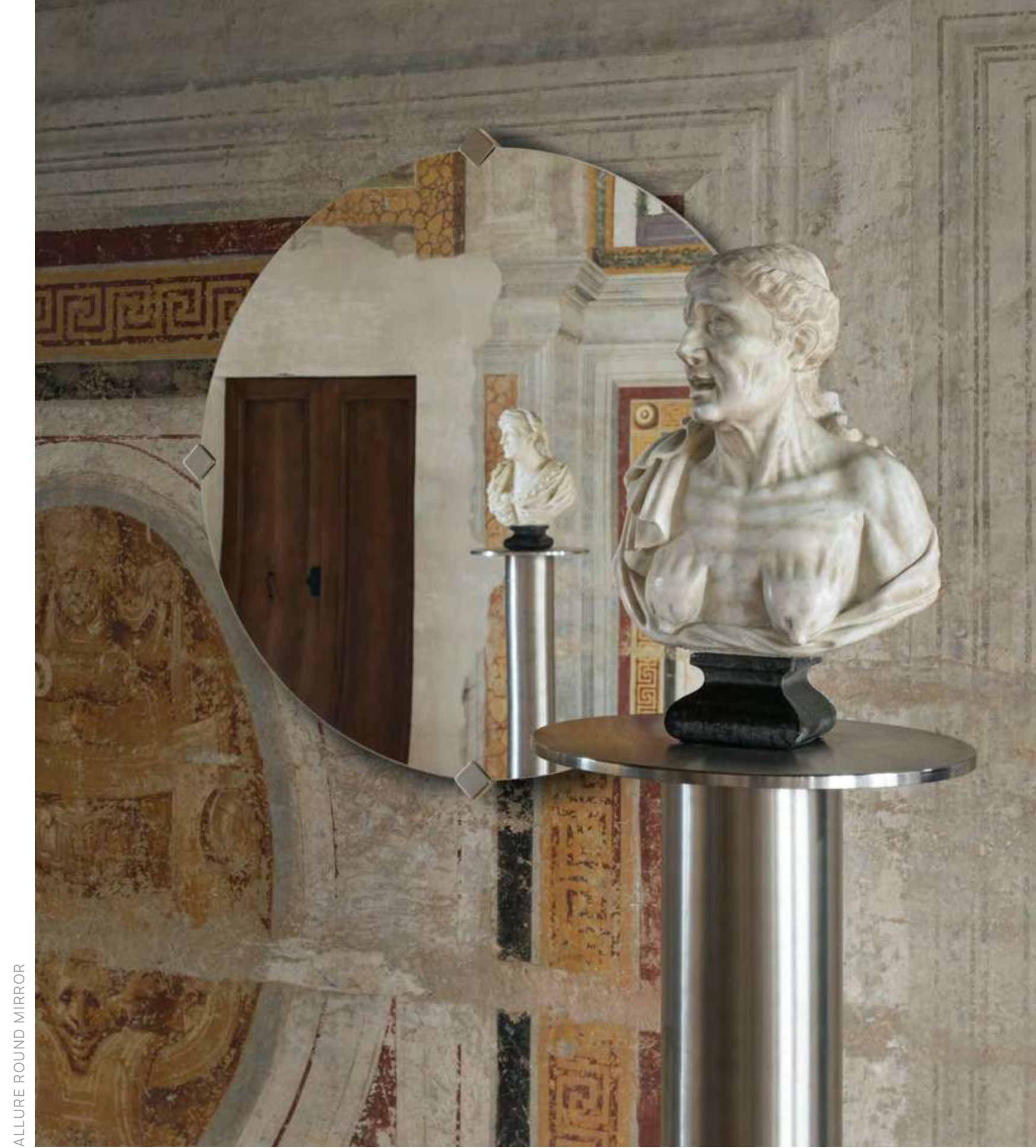

ALLURE ROUND MIRROR



ANTIBES NIGHT TABLE



ANTIBES CHEST OF DRAWERS

**EXPRESSING AN ECLECTIC APPROACH, THE MONOGRAPHY COLLECTION OFFERS A WIDE SELECTION OF METICULOUSLY CRAFTED FURNITURE, AIMED AT COMPLEMENTING SLEEPING SPACES WITH AN UNUSUAL TYPE OF BEAUTY. THE TIMELESS AESTHETIC OF OUR FURNISHINGS AND MASTERFUL WORKMANSHIP OF MATERIALS ARE THE TRUE SECRET TO AN ELEGANT LIVING SENSATION.**

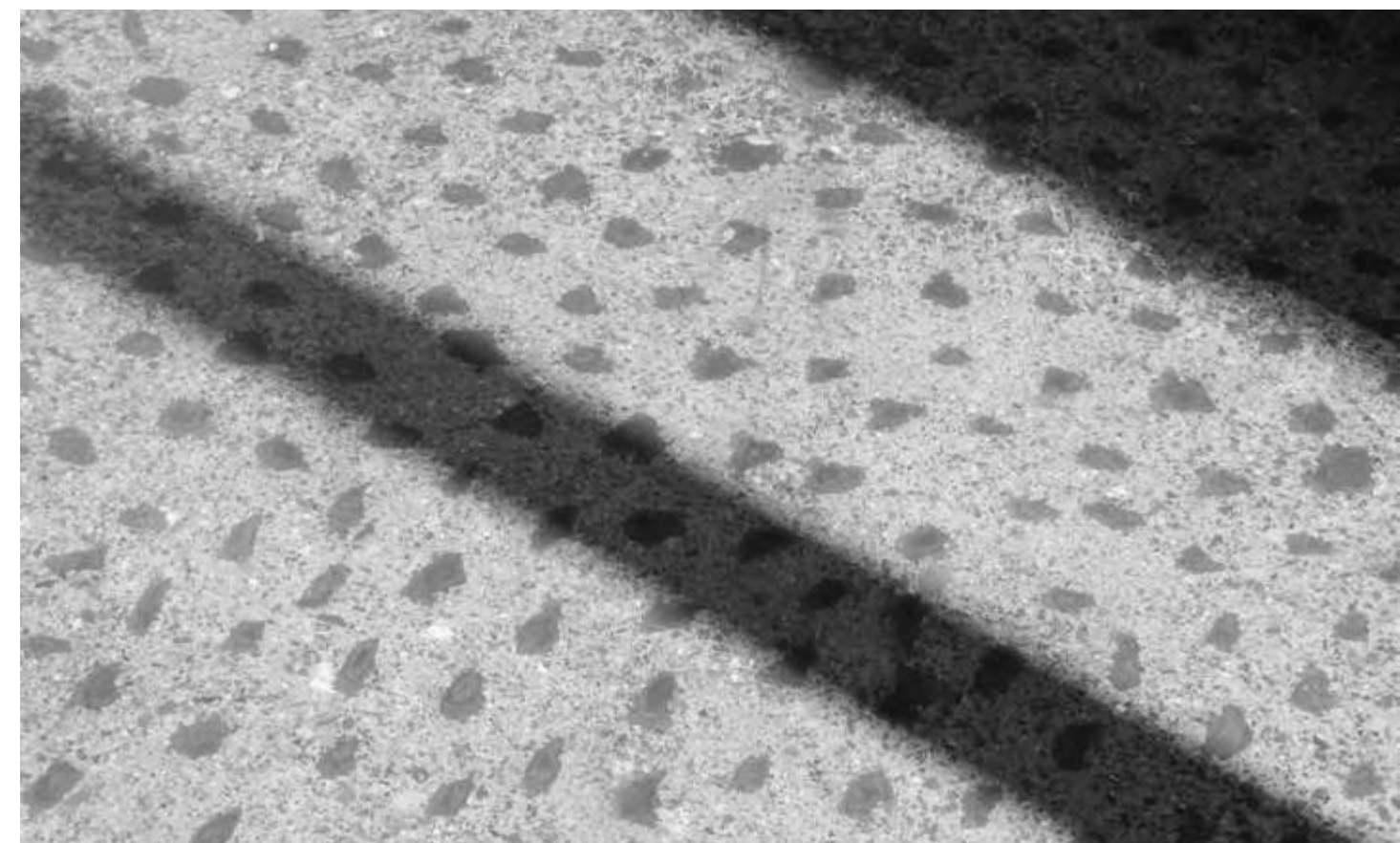

CHELSEA BED QUEEN SIZE, MAGIC NIGHT TABLE, MAGIC CHEST OF DRAWERS







MAGIC NIGHT TABLE, MAGIC CHEST OF DRAWERS



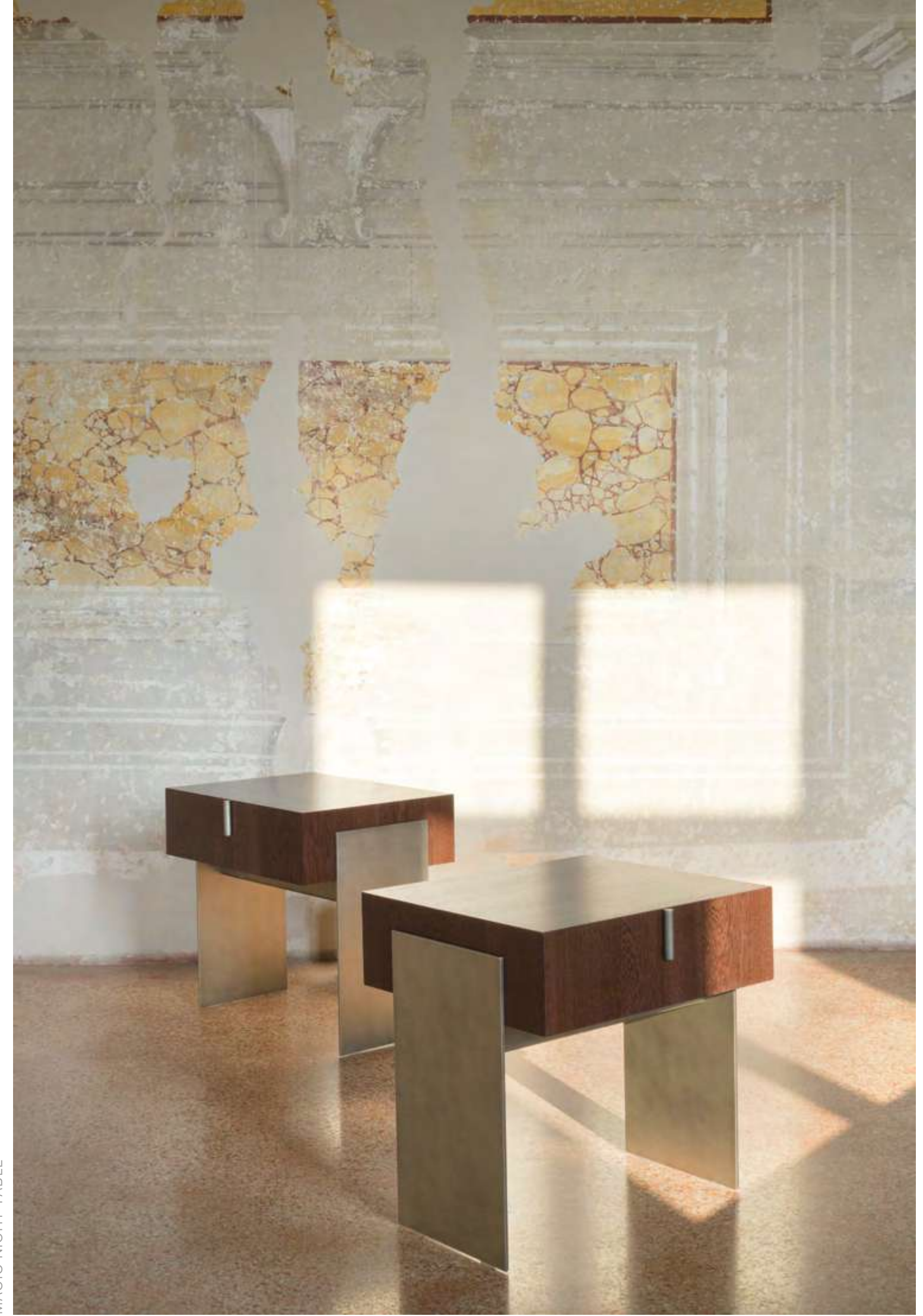

MAGIC NIGHT TABLE



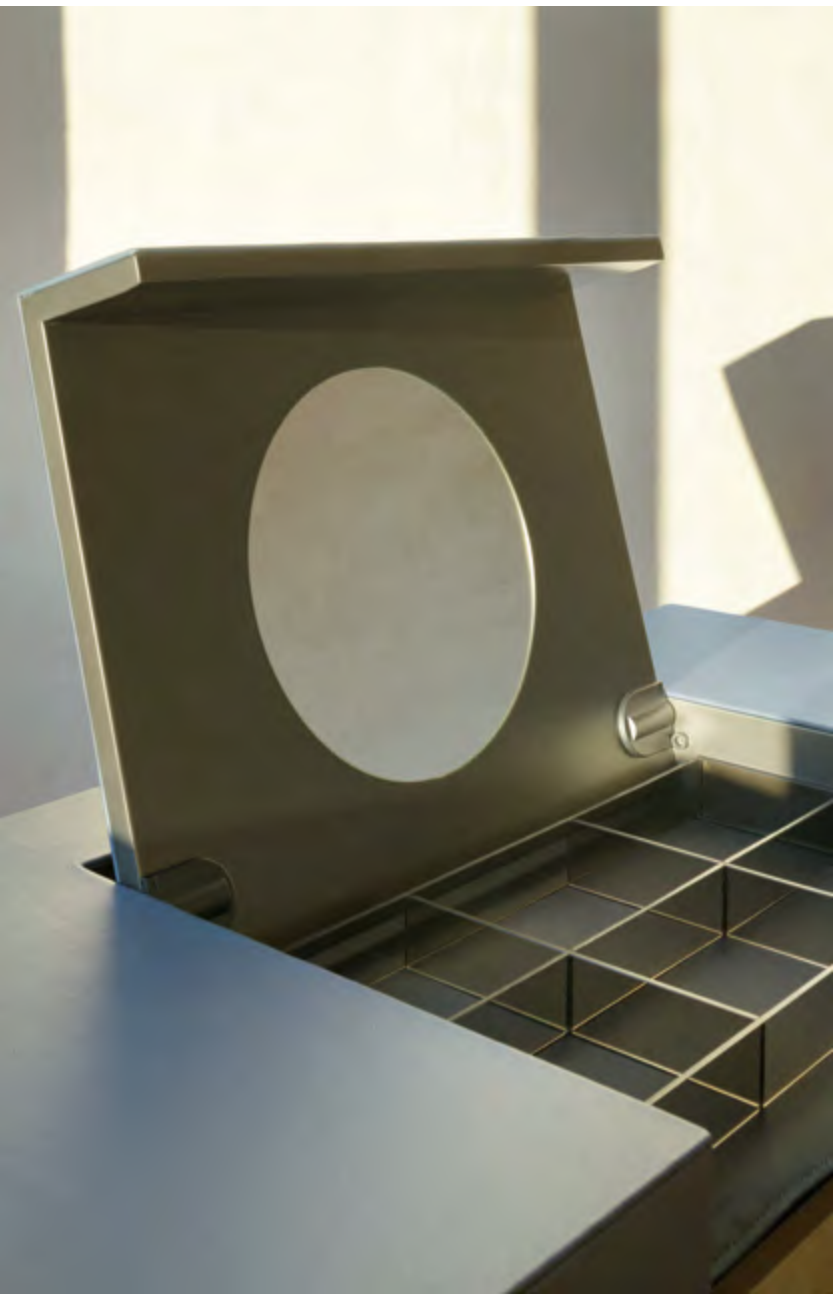

MAGIC DRESSING, TWILLY CHAIR WITH ARMS

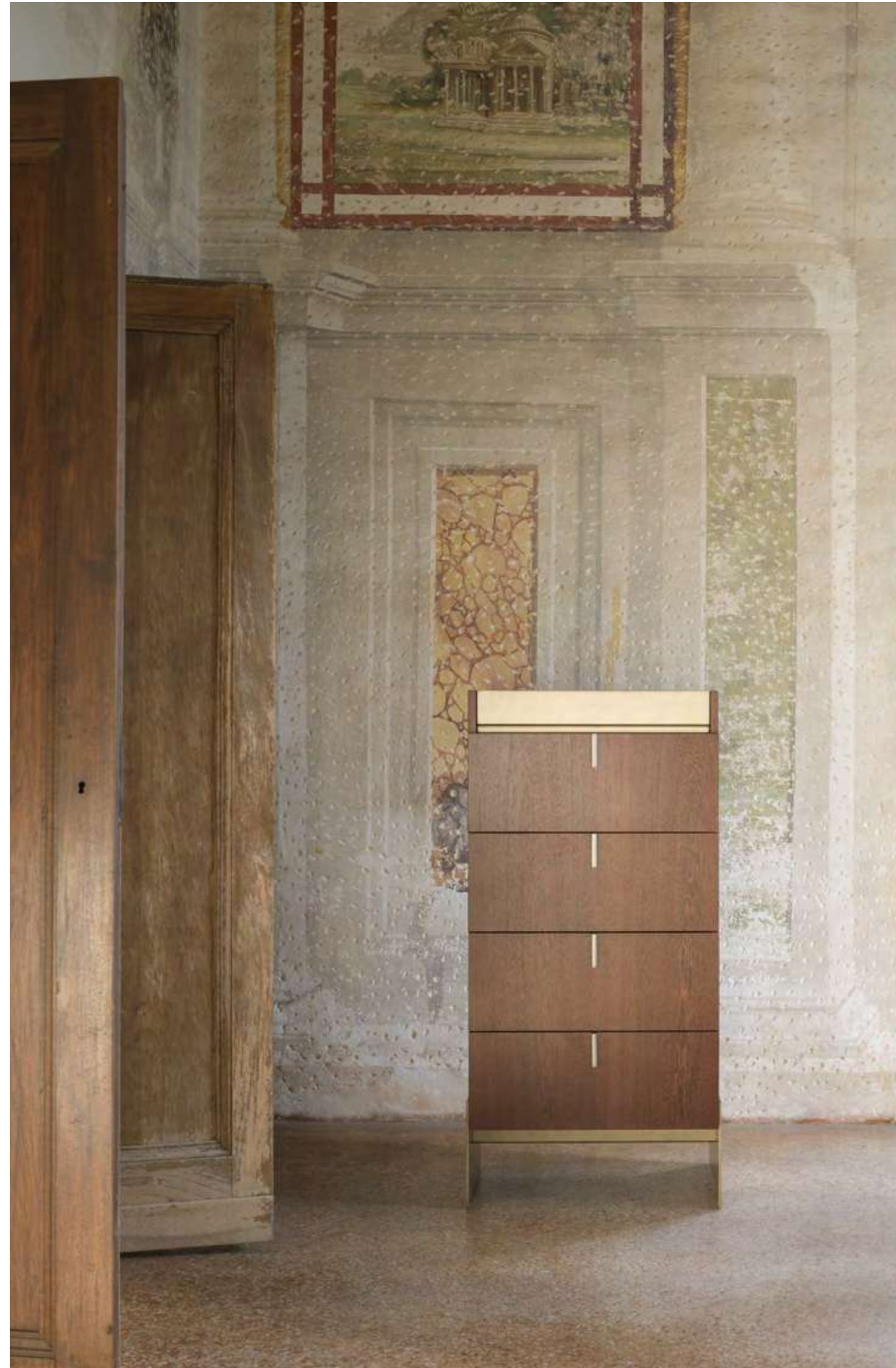

MAGIC HIGHBOY

AN ETHEREAL CELEBRATION OF UNIQUENESS AND UTMOST ALLURING BEAUTY. EACH PIECE IS CONCEIVED TO CONVEY A SENSE OF INTIMATE REFINEMENT AND ALCHEMICAL SOPHISTICATION. A DYNAMIC OXYMORON: CLEAN LINES AND SHAPES ARE JUXTAPOSED WITH THE CHOICE OF STRONG-CHARACTER MATERIALS, DARINGLY PAIRED TOGETHER.





TAMBOUR RUG







SOFAS



ALAYA ASIX → P. 174    ATRIUM → P. 175    COLINE → P. 176    LOUISE → P. 177    VAGUE → P. 178

MODULAR SOFAS



ALAYA → P. 180    ATRIUM → P. 182

ARMCHAIRS



ARAMIS → P. 184    JEAN → P. 184    TWILLY → P. 185    VAGUE → P. 185

SOFA TABLES



ALAYA central table → P. 186    ALAYA courtesy table → P. 186    ALLURE central table → P. 187    ALLURE side table → P. 187    ANTIBES central table → P. 188    PETITE side table → P. 191



SOL side table → P. 188    SOL sofa table → P. 189    SOL sofa table composition → P. 189    TRUFFLE sofa table → P. 190

DINING TABLES



DOMINO top → P. 192    MIKADO top → P. 193    ORIGAMI top → P. 194    SEGMENTI top → P. 195



ANTIBES base → P. 196    CARTESIO base → P. 197    MEZZALUNA base → P. 198

CHAIRS



CLAIRE → P. 202    MAXIME → P. 200    MAXIME SOFT → P. 200    TWILLY → P. 201    TWILLY with arms → P. 201

BEDS



ASTORIA → P. 204    CHELSEA → P. 204    HYDE PARK → P. 205    SOHO → P. 205

BEDROOM COMPLEMENTS



ANTIBES chest of drawers → P. 206    ANTIBES night table → P. 206    MAGIC chest of drawers → P. 207    MAGIC dressing → P. 207    MAGIC highboy → P. 208    MAGIC night table → P. 208

CUPBOARDS AND LIBRARIES



MEMORIES display cabinet → P. 211    MONTREAL bookshelf → P. 212    NUAGE sideboard → P. 210    NUAGE tv cabinet → P. 210

OCCASIONALS AND DESKS



ALAYA console → P. 214    GALA desk → P. 214    MEZZALUNA console → P. 216    MONTREAL backsofa console → P. 215    MONTREAL console → P. 215

DECORATIONS



ALLURE mirror → P. 218    HYDE PARK wall decoration → P. 218    REFLECT mirror → P. 219    SEGMENTI wall decoration → P. 219

RUGS



NOMAD → P. 220    TAMBOUR → P. 220

**ALAYA ASIX sofa**  
Bernhardt & Vella



Solid wood frame, metal feet, finishing in MO.508 delabrè copper smooth, with detail in MO.503 brushed natural brass. Multiple density polyurethane foam for seat and body. Available in left and right higher back. Decorative pillows on request.

Editorial story → P.007  
Materials & technical drawings → QR Code



ALAYA ASIX 2 seats

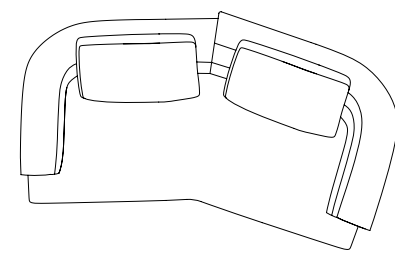
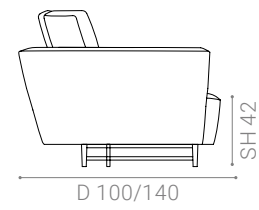
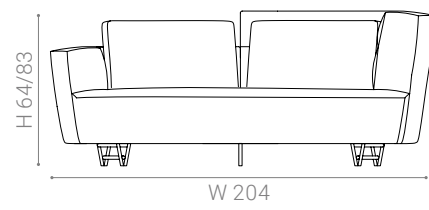

ALAYA ASIX 3 seats

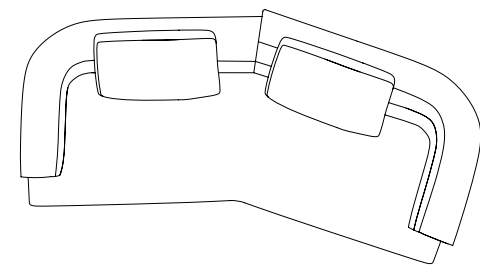
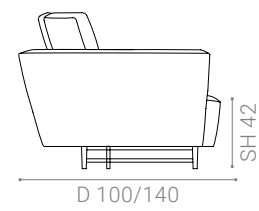
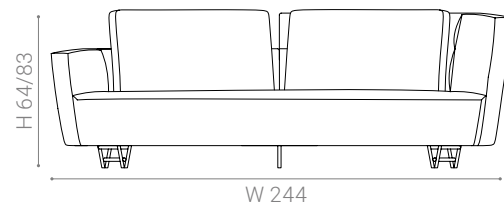

ALAYA ASIX 4 seats

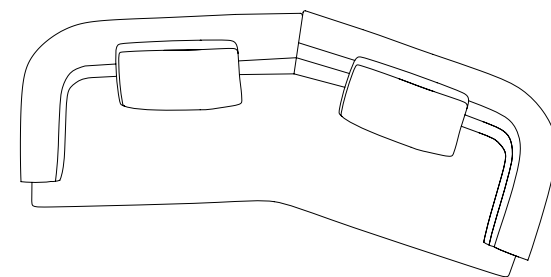
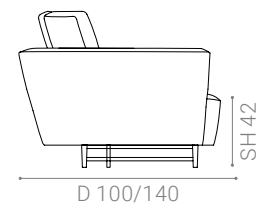
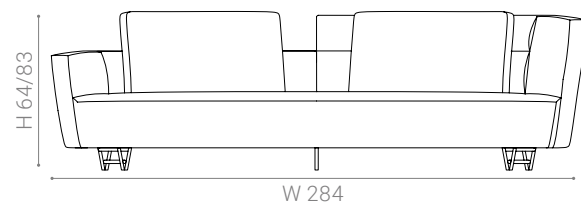

**ATRIUM sofa**  
Bernhardt & Vella



Solid wood frame, metal base and shell, metallic finishing only. Seat and back cushions in natural feather with polyurethane insert. Decorative pillows on request.

Editorial story → P.051  
Materials & technical drawings → QR Code



ATRIUM 2 seats

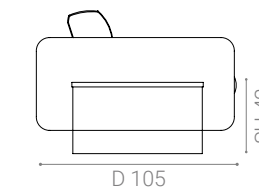
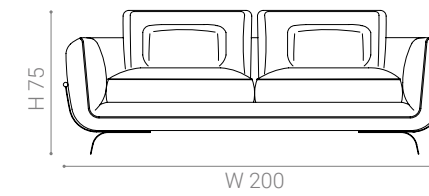

ATRIUM 3 seats

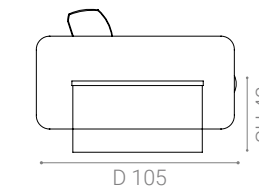
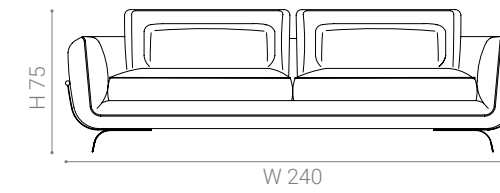

ATRIUM 4 seats

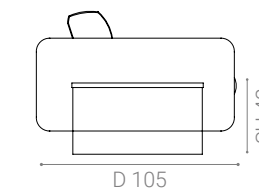
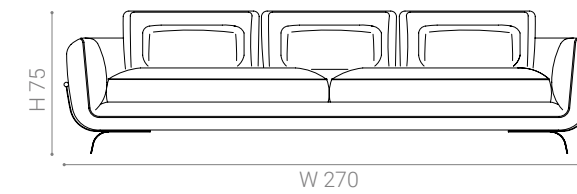



**COLINE sofa**  
Bernhardt & Vella



Solid wood frame, metal feet, brushed metallic finishing only. Multiple density polyurethane foam for seat and body. Decorative pillows on request.

Editorial story → P. 083  
Materials & technical drawings → QR Code



COLINE 2 seats

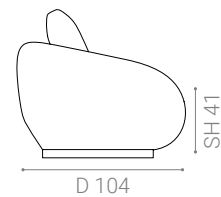
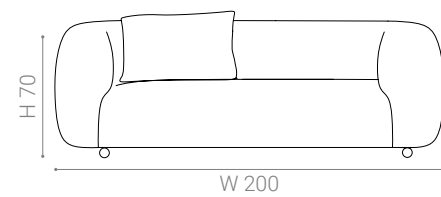

COLINE 3 seats

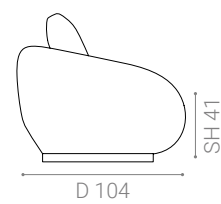
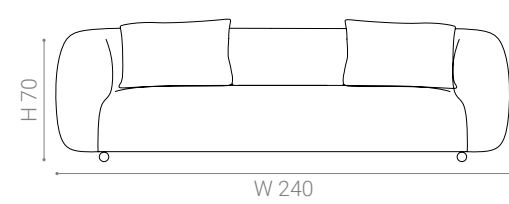

COLINE 4 seats

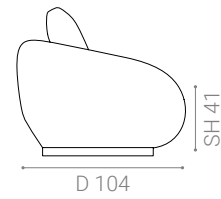
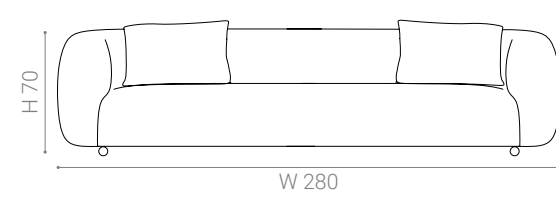

**LOUISE sofa**  
Bernhardt & Vella



Solid wood frame, metal feet, finishing in MO.508 delabrè copper smooth. Multiple density polyurethane foam and feather for seat and body. Decorative pillows on request.

Editorial story → P. 075  
Materials & technical drawings → QR Code



LOUISE 2 seats

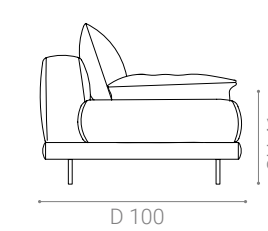
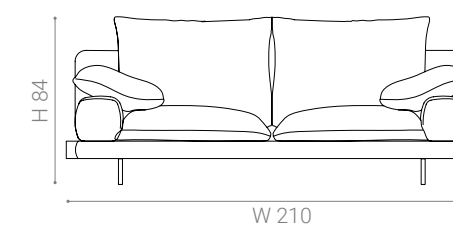

LOUISE 3 seats

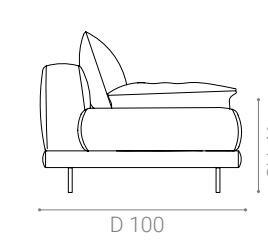
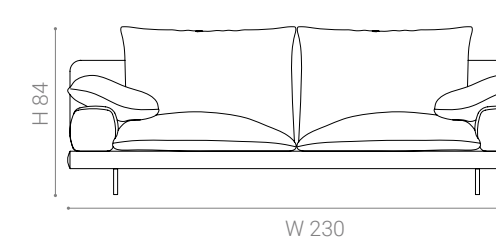

LOUISE 4 seats

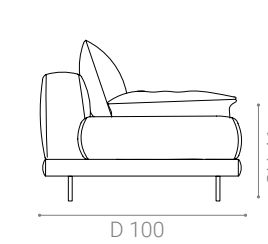
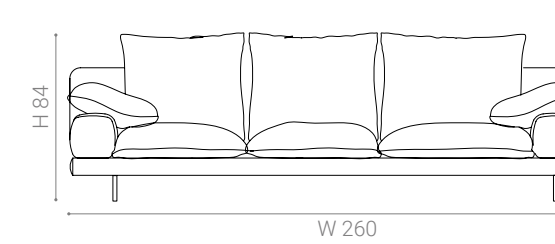

**VAGUE sofa**  
Bernhardt & Vella



Solid wood frame, wooden base. Available in lacquered and metallic finishings. Seat cushions and back part in natural feather with polyurethane insert. Decorative pillows on request

Editorial story → P.065  
Materials & technical drawings → QR Code



VAGUE 2 seats

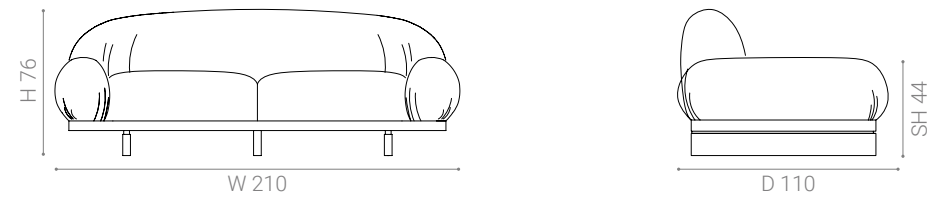

VAGUE 3 seats

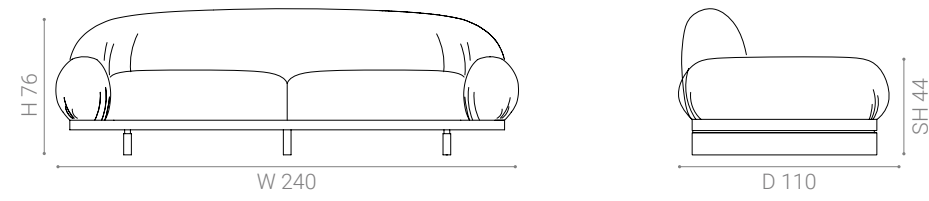

VAGUE 4 seats

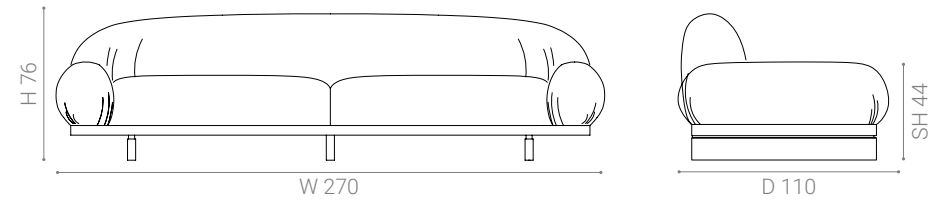

**ALAYA modular sofa**  
Bernhardt & Vella



Solid wood frame, metal feet, finishing in MO.508 delabrè copper smooth, with detail in MO.503 brushed natural brass. Multiple density polyurethane foam for seat and body. Available in left and right element. Decorative pillows on request.

Editorial story → P.020  
Materials & technical drawings → QR Code

ALAYA side element low 135

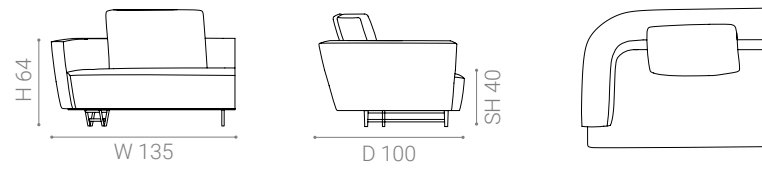

ALAYA side element high 135

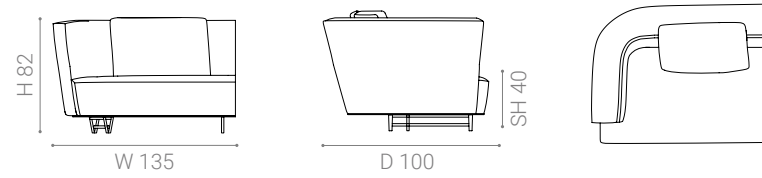

ALAYA side element low 220

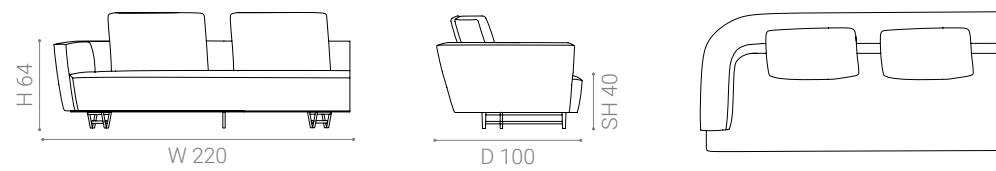

ALAYA side element high 220

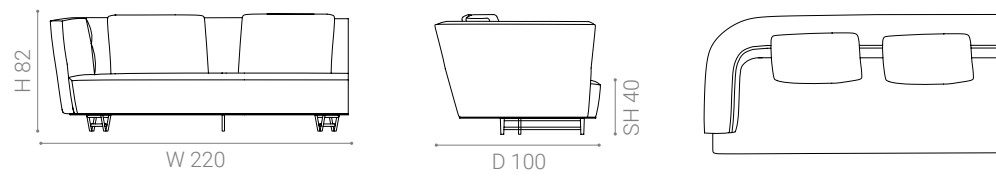

ALAYA side element low corner short

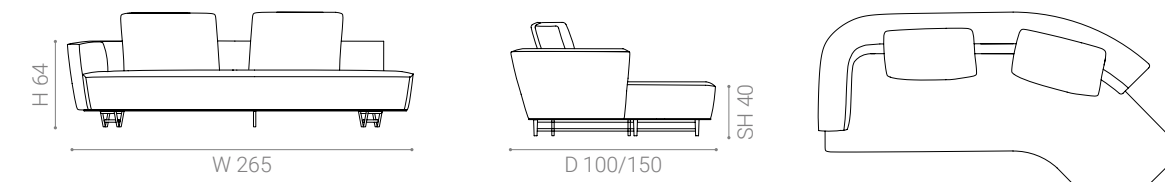

ALAYA side element high corner short

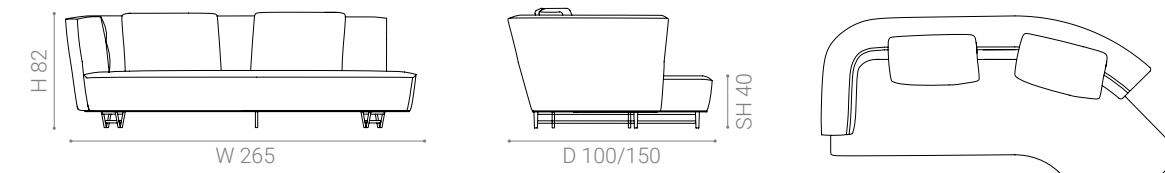

ALAYA side element low dormeuse

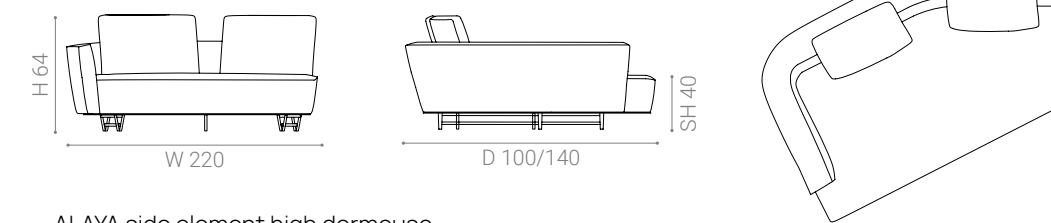

ALAYA side element high dormeuse

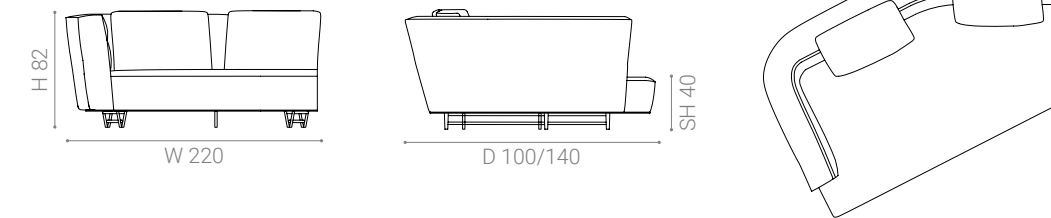

**ATRIUM modular sofa**  
Bernhardt & Vella



Solid wood frame, metal base and shell, metallic finishing only. Seat and back cushions in natural feather with polyurethane insert. Available in left and right element. Decorative pillows on request.

Editorial story → P. 037  
Materials & technical drawings → QR Code

ATRIUM side element 115

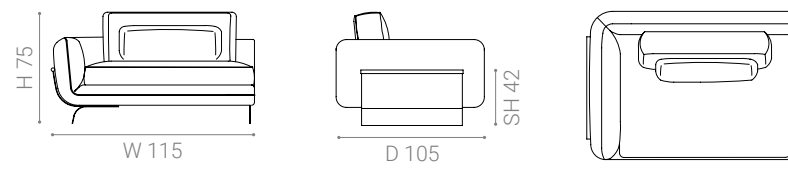

ATRIUM corner element

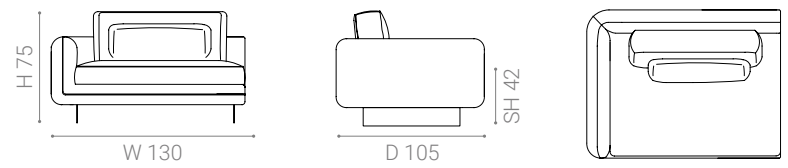

ATRIUM side element 200 double cushion

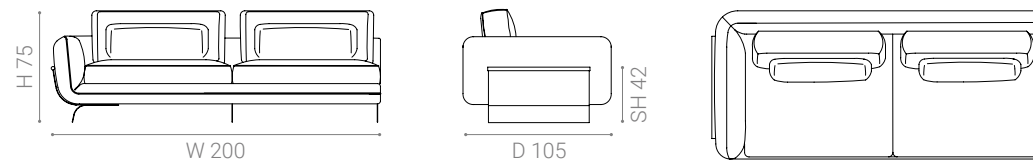

ATRIUM side element 200 single cushion + pouf

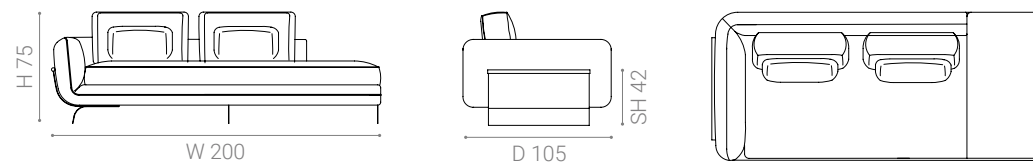

ATRIUM side element 200 single cushion + marble top

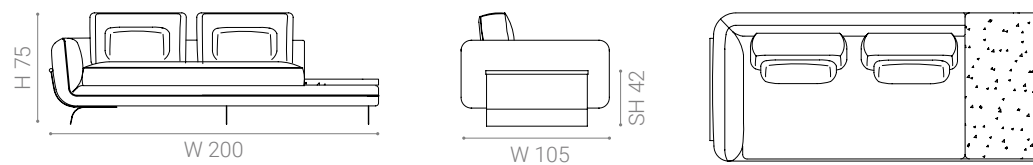

ATRIUM side element 250 single cushion + pouf

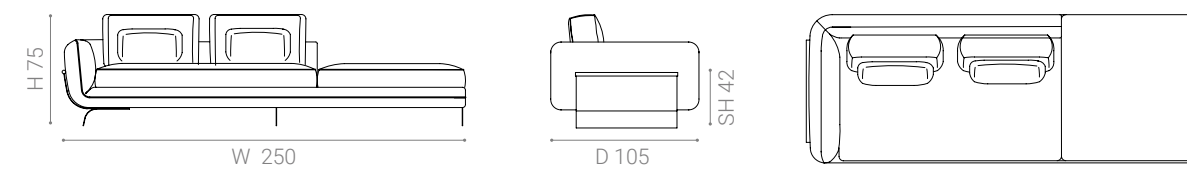

ATRIUM side element 250 single cushion + marble top

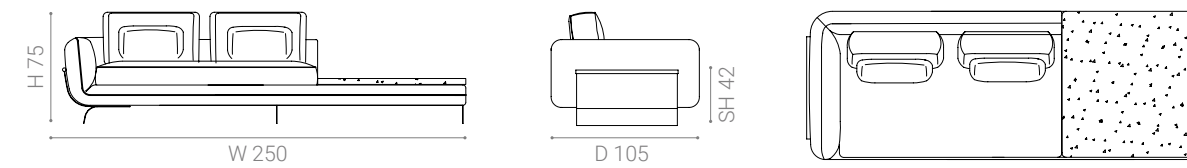

ATRIUM side element 250 double cushion + pouf

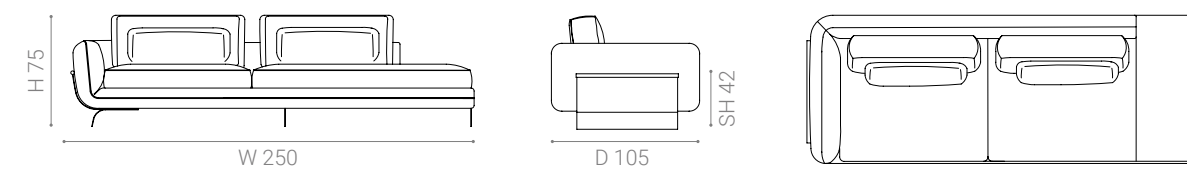

ATRIUM side element 250 double cushion + marble top

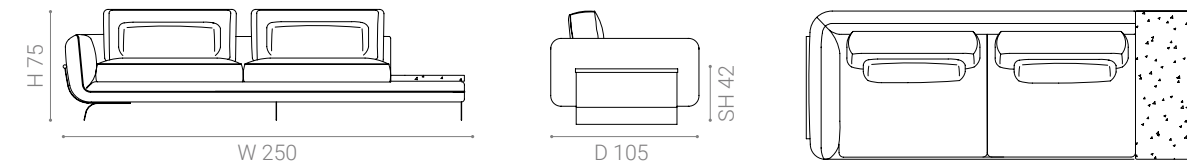

ATRIUM chaise longue

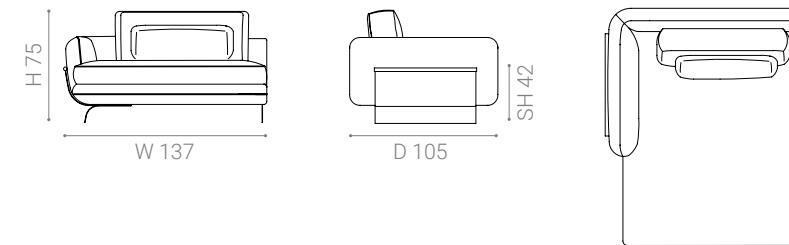

ATRIUM pouf

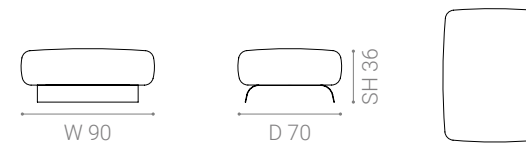

**ARAMIS armchair**  
Bernhardt & Vella

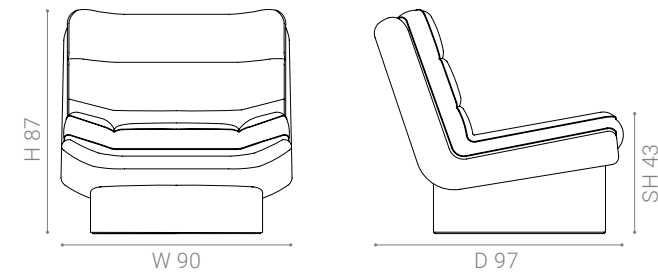

Solid wood frame, swivel base, metallic finishing only. Seat and back padding in multi-density polyurethane foam.

Editorial story → P. 025  
Materials & technical drawings → QR Code



**TWILLY armchair**  
Bernhardt & Vella

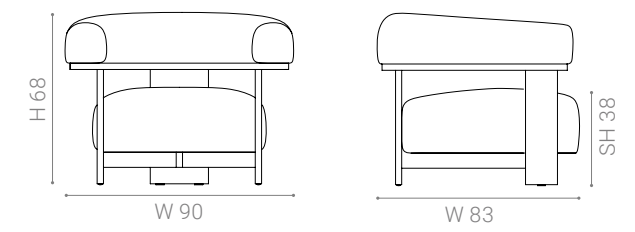

Solid wood frame, lacquered finishing only. Seat and back padding in multi-density polyurethane foam.

Editorial story → P. 015  
Materials & technical drawings → QR Code



**JEAN armchair**  
Bernhardt & Vella

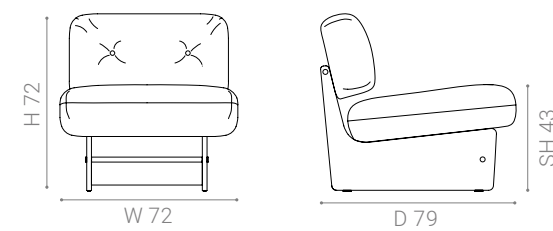

Plywood base, available in Onyge veneer, metal details. Seat and back cushions in multi-density polyurethane foam.

Editorial story → P. 045  
Materials & technical drawings → QR Code



**VAGUE armchair**  
Bernhardt & Vella

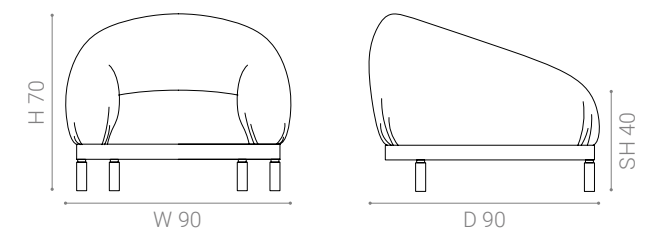

Solid wood frame, wooden base. Available in lacquered and metallic finishings. Seat cushions and back part in natural leather with polyurethane insert.

Editorial story → P. 061  
Materials & technical drawings → QR Code



**ALAYA central table**  
Bernhardt & Vella

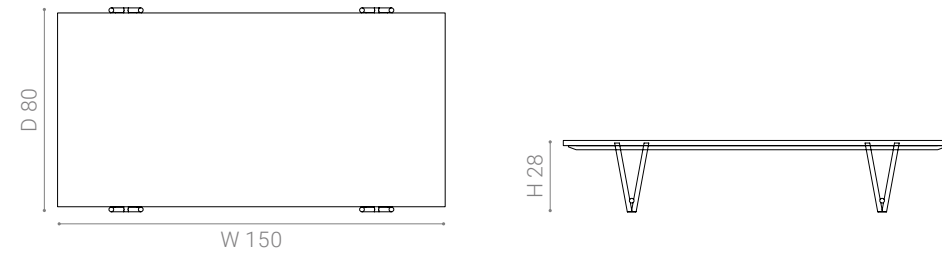

Metal base, finishing in MO.508 delabrè copper smooth, with detail in MO.503 brushed natural brass. Top available in bi color Onyge marquetry or marble only.

Editorial story → P. 013  
Materials & technical drawings → QR Code



**ALLURE central table**  
Bernhardt & Vella

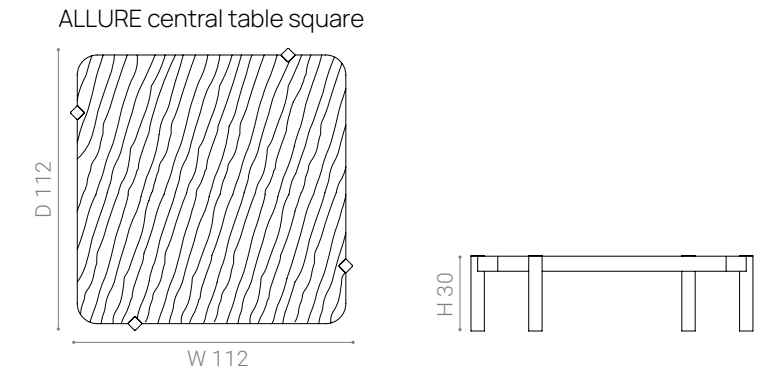

Plywood structure, available in Onyge marquetry only. Metal details.

Editorial story → P. 031  
Materials & technical drawings → QR Code

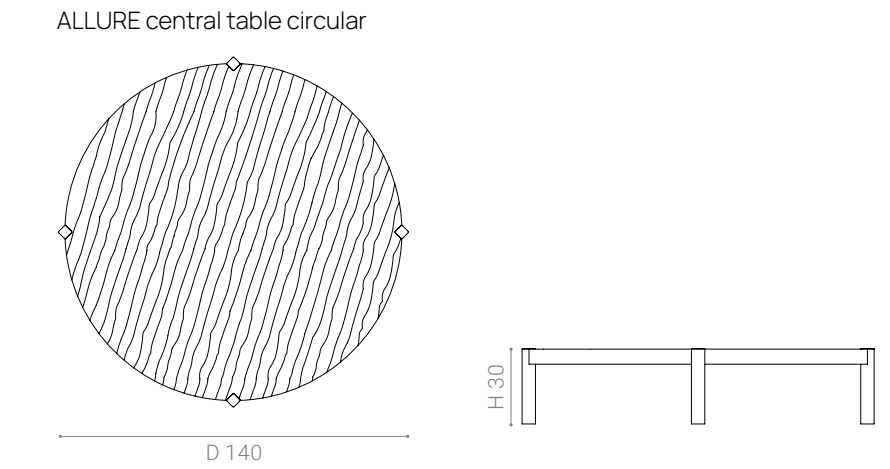

**ALAYA courtesy table**  
Bernhardt & Vella

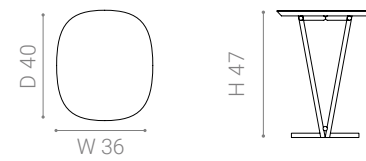

Metal base, finishing in MO.508 delabrè copper smooth, with detail in MO.503 brushed natural brass. Top available in bi color Onyge marquetry or marble only.

Editorial story → P. 011  
Materials & technical drawings → QR Code



**ALLURE side table**  
Bernhardt & Vella

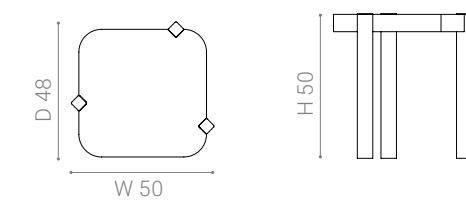

Plywood structure, lacquered and metallic finishing only.

Editorial story → P. 055  
Materials & technical drawings → QR Code



**ANTIBES central table**  
Bernhardt & Vella

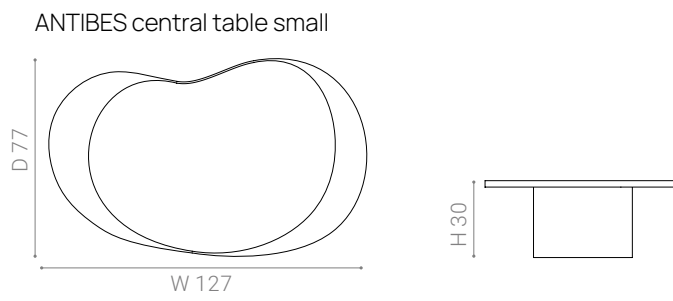
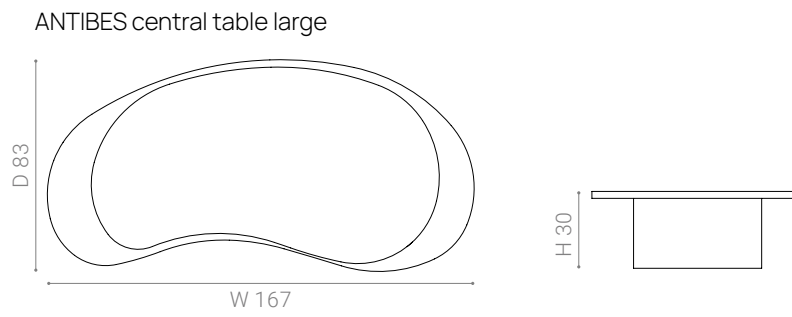
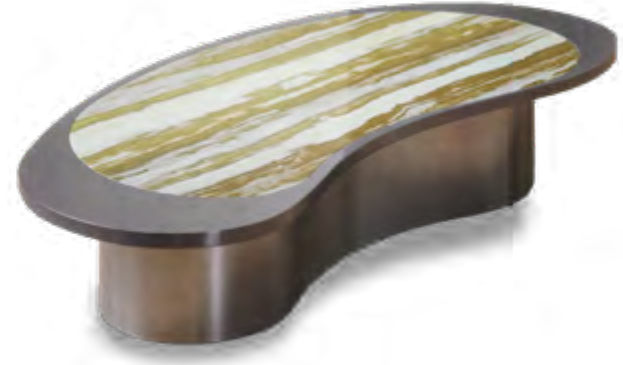

Wooden structure, lacquered and metallic finishing. Top available in wood or marble.

Editorial story → P. 022  
Materials & technical drawings → QR Code



**SOL sofa table**  
Bernhardt & Vella

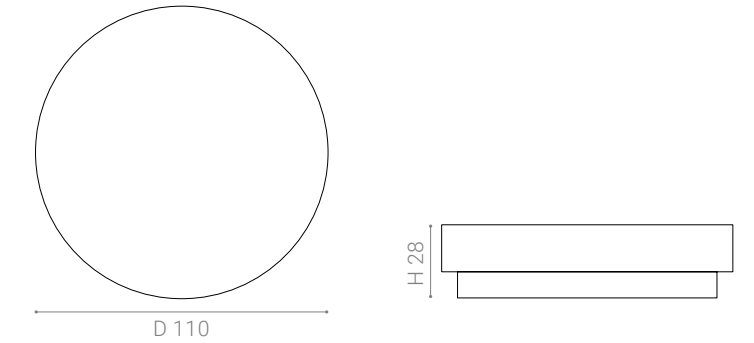
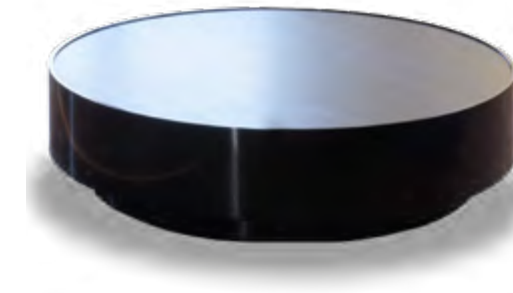

Wooden structure, lacquered and metallic finishing. Top available in Onyge veneer or marble.

Editorial story → P. 088  
Materials & technical drawings → QR Code



**SOL side table**  
Bernhardt & Vella

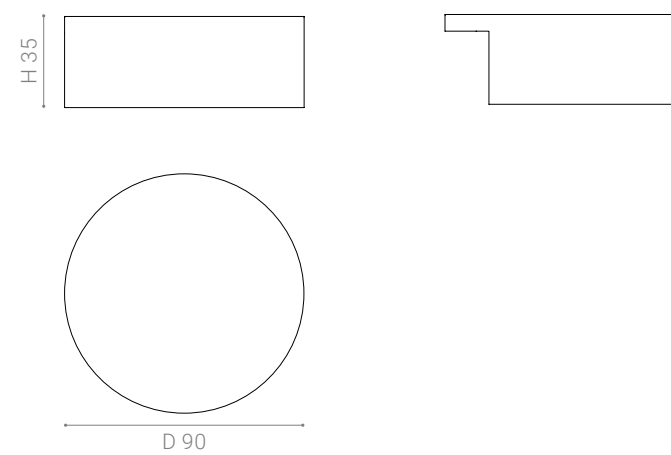
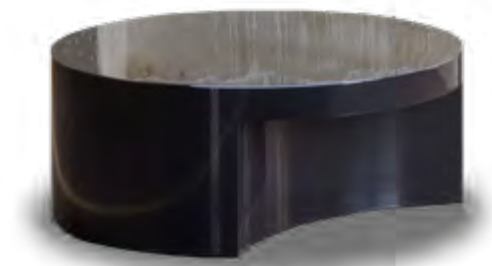

Wooden structure, lacquered and metallic finishing. Top available in Onyge veneer or marble.

Editorial story → P. 088  
Materials & technical drawings → QR Code



**SOL sofa table composition**  
Bernhardt & Vella

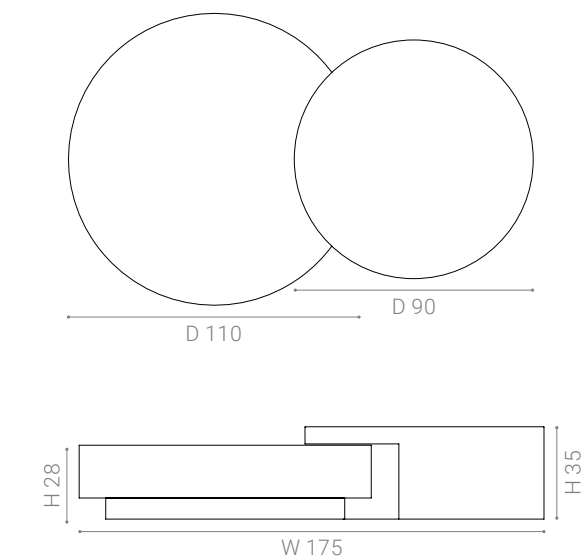
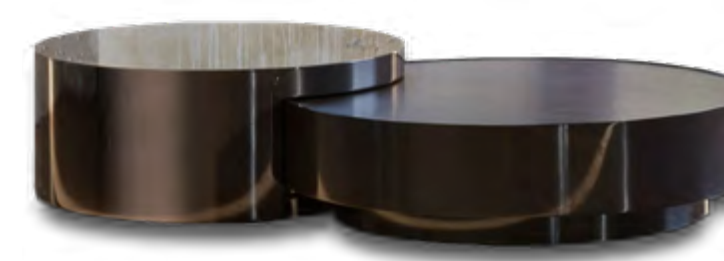

Wooden structure, lacquered and metallic finishing. Top available in Onyge veneer or marble.

Editorial story → P. 089  
Materials & technical drawings → QR Code



**TRUFFLE sofa table**  
Bernhardt & Vella



TRUFFLE 120 sofa table

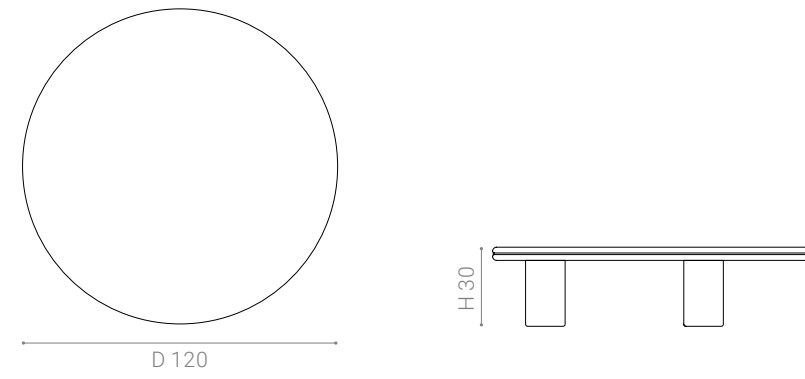

Wooden structure, available in metallic and lacquered finishing only.

Editorial story → P. 081  
Materials & technical drawings → QR Code



TRUFFLE 80 sofa table

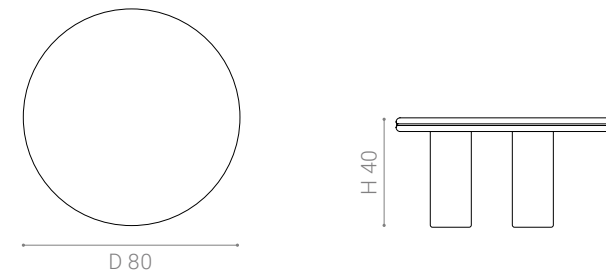

**TRUFFLE 45 sofa table**  
Bernhardt & Vella

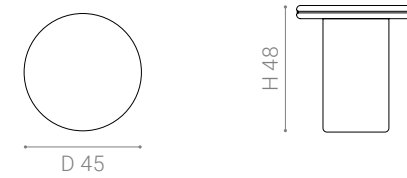

Wooden structure, available in metallic and lacquered finishing only.

Editorial story → P. 081  
Materials & technical drawings → QR Code



**PETITE side table**  
Bernhardt & Vella

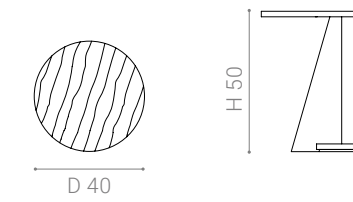

Plywood structure, available in Onyge veneer marquetry.

Editorial story → P. 042  
Materials & technical drawings → QR Code





**DOMINO table top**  
Bernhardt & Vella



DOMINO top

Plywood and mdf, lacquered finishing only.  
Brushed metal details.

Editorial story → P.107  
Materials & technical drawings → QR Code

**MIKADO table top**  
Bernhardt & Vella

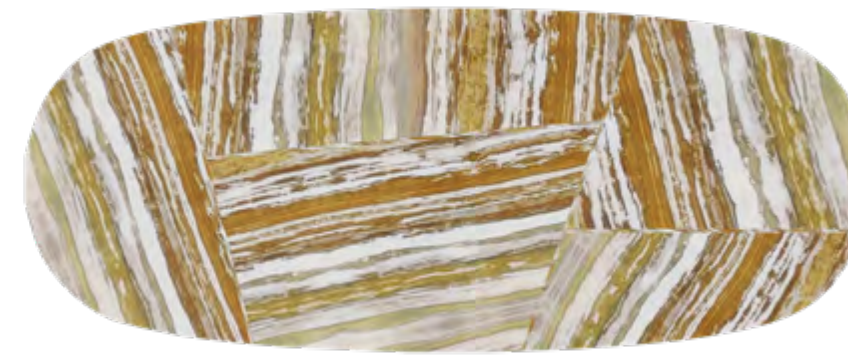

MIKADO top

Composite marble with wooden backing.

Editorial story → P.124  
Materials & technical drawings → QR Code

**DOMINO top for round table 160**

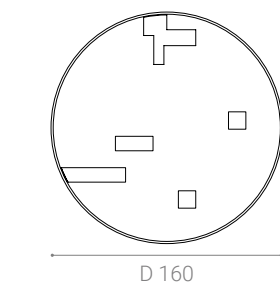

Base suitable for round top

ANTIBES base for round top

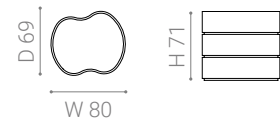

CARTESIO base for round top

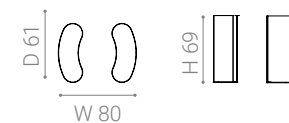

MEZZALUNA base for round top

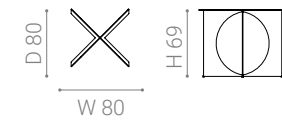

**MIKADO top for round table 160**

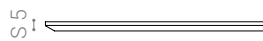
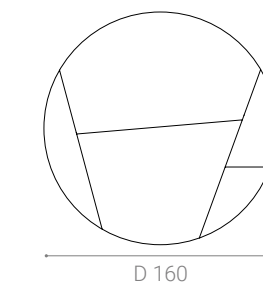

Base suitable for round top

ANTIBES base for round top

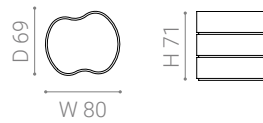

CARTESIO base for round top



MEZZALUNA base for round top

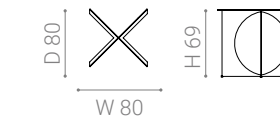

**DOMINO top for oval table 240**

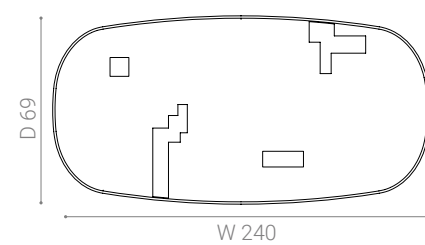

Base suitable for oval top

ANTIBES base for oval top

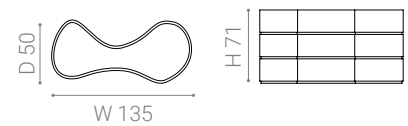

**DOMINO top for oval table 300**

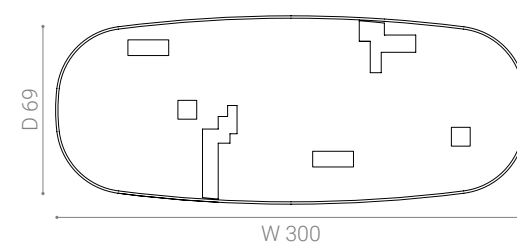

CARTESIO base for oval top

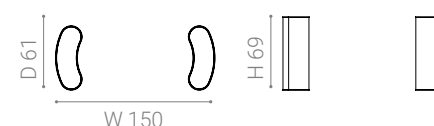

MEZZALUNA base oval round top



**MIKADO top for oval table 240**

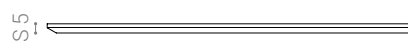
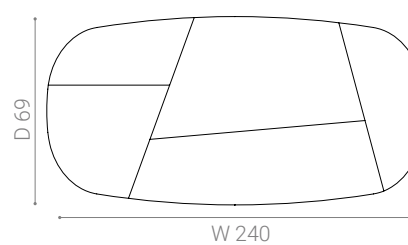

Base suitable for oval top

ANTIBES base for oval top

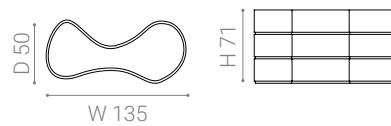

**MIKADO top for oval table 300**

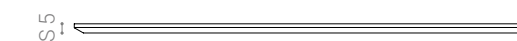
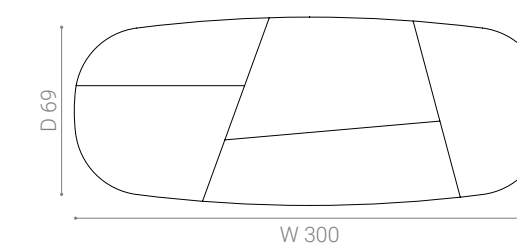

CARTESIO base for oval top

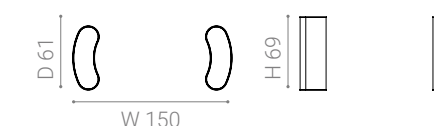

MEZZALUNA base oval round top



**ORIGAMI table top**  
Bernhardt & Vella



ORIGAMI top

Plywood top with marquetry, available in MO.350 Onyge brown veneer and MO.351 Onyge black veneer, only.

Editorial story → P.103  
Materials & technical drawings → QR Code

**SEGMENTI table top**  
Bernhardt & Vella



SEGMENTI top

Plywood top with marquetry, available in MO.352 Onyge red veneer and metal insert in MO.506 brushed silver brass.

Editorial story → P.097  
Materials & technical drawings → QR Code

**ORIGAMI top for round table 160**

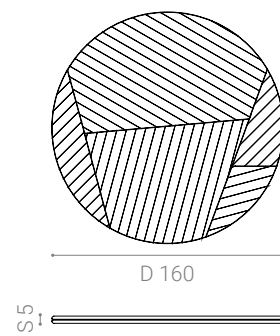

Base suitable for round top

ANTIBES base for round top

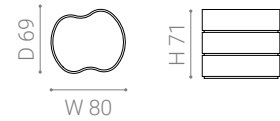

CARTESIO base for round top

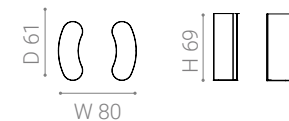

MEZZALUNA base for round top

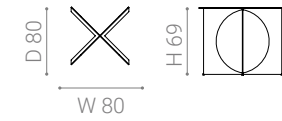

**SEGMENTI top for round table 160**

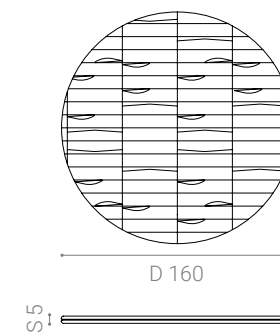

Base suitable for round top

ANTIBES base for round top

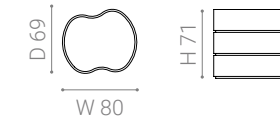

CARTESIO base for round top

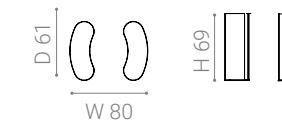

MEZZALUNA base for round top

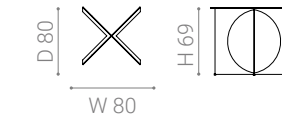

**ORIGAMI top for oval table 240**

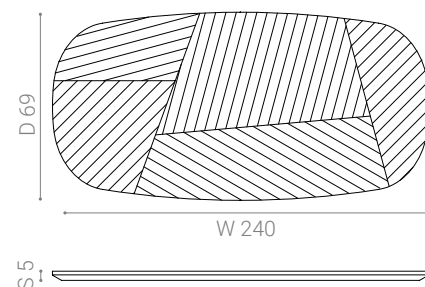

Base suitable for oval top

ANTIBES base for oval top

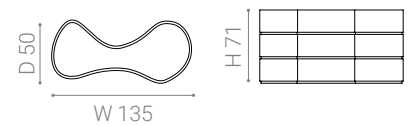

**ORIGAMI top for oval table 300**

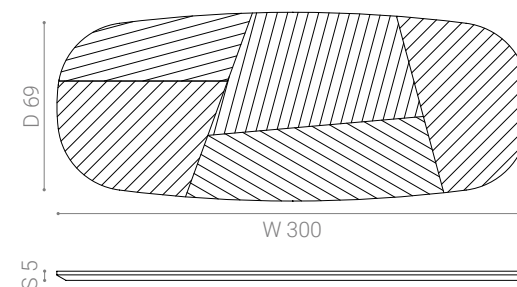

CARTESIO base for oval top

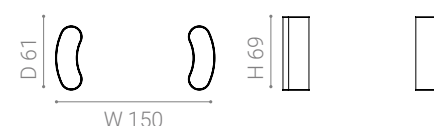

MEZZALUNA base oval round top



**SEGMENTI top for oval table 240**

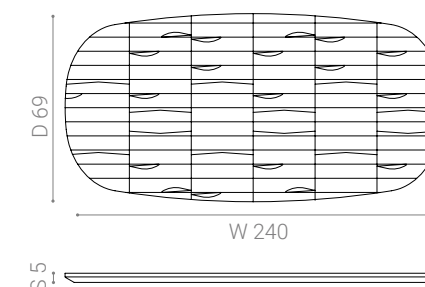

Base suitable for oval top

ANTIBES base for oval top

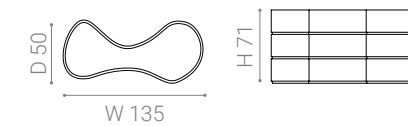

**SEGMENTI top for oval table 300**

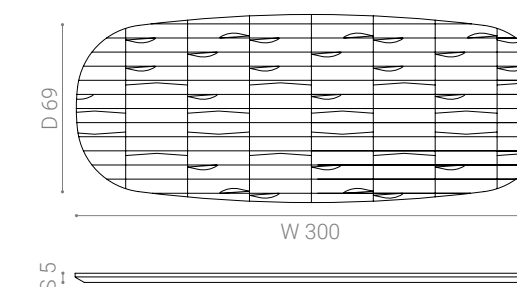

CARTESIO base for oval top

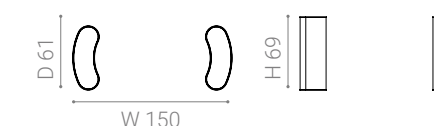

MEZZALUNA base oval round top



**ANTIBES table base**  
Bernhardt & Vella



ANTIBES base

Wooden structure, metallic finishing only.  
Available for oval and round top.

Editorial story → P. 107  
Materials & technical drawings → QR Code



**CARTESIO table base**  
Bernhardt & Vella



CARTESIO base

Base composed by 2 elements, wooden structure, leather padded.  
Available for oval and round top.

Editorial story → P. 120  
Materials & technical drawings → QR Code



**ANTIBES base for round table**

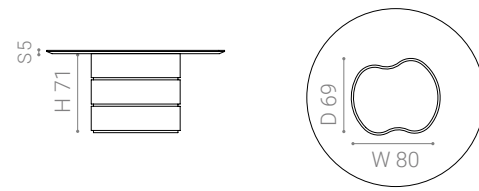

Top suitable for round base

DOMINO top for round table

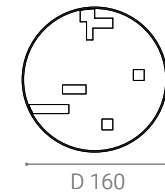

MIKADO top for round table

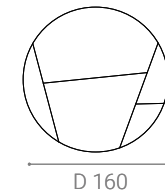

ORIGAMI top for round table

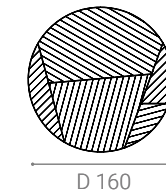

SEGMENTI top for round table

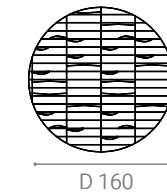

**ANTIBES base for oval table**

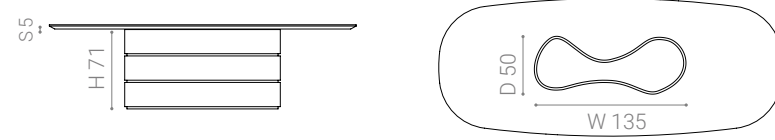

Top suitable for oval base

DOMINO top for oval table

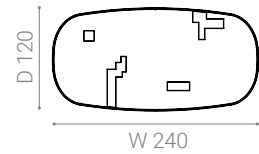

MIKADO top for oval table

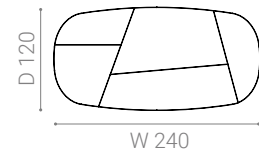

ORIGAMI top for oval table

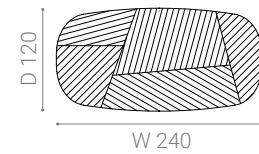

SEGMENTI top for oval table

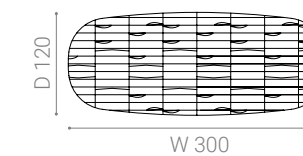
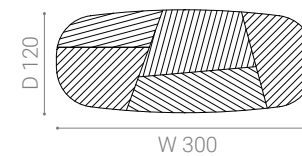
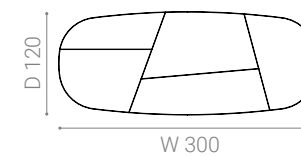
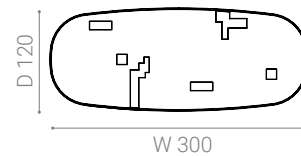
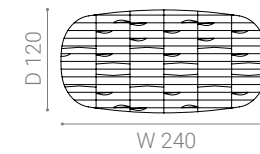

**CARTESIO base for round table**

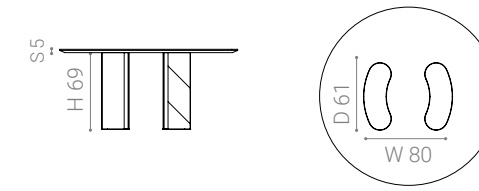

Top suitable for round base

DOMINO top for round table

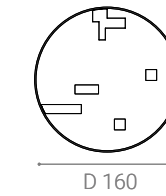

MIKADO top for round table

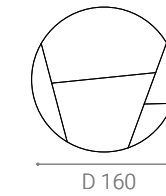

ORIGAMI top for round table

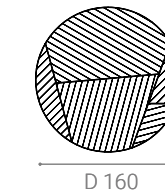

SEGMENTI top for round table

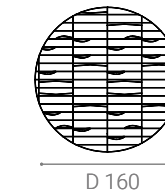

**CARTESIO base for oval table**

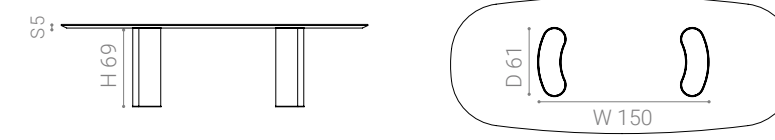

Top suitable for oval base

DOMINO top for oval table

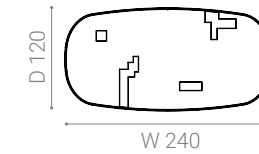

MIKADO top for oval table

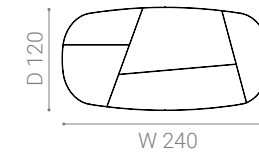

ORIGAMI top for oval table

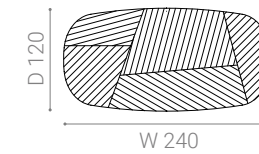

SEGMENTI top for oval table

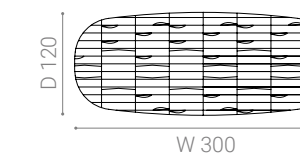
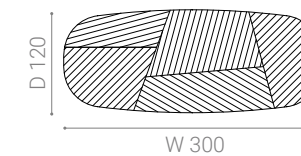
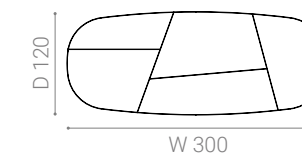
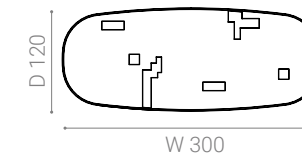
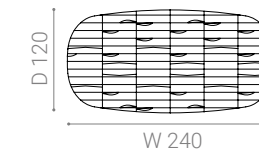

**MEZZALUNA table base**  
Bernhardt & Vella



MEZZALUNA base

Metal structure , laser cut, lacquered  
and metallic finishing.  
Available for oval and round top.

Editorial story → P. 097  
Materials & technical drawings → QR Code



**MEZZALUNA base for round table**

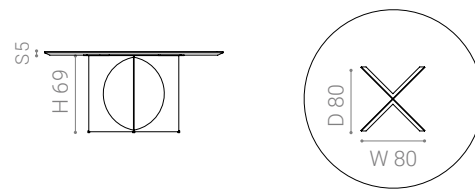

Top suitable for round base

DOMINO top for round table

MIKADO top for round table

ORIGAMI top for round table

SEGMENTI top for round table

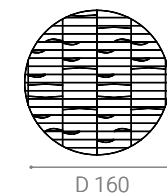
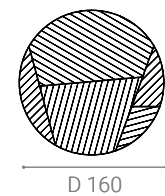
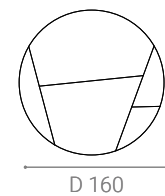
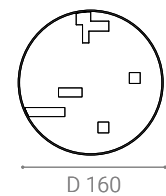

**MEZZALUNA base for oval table**

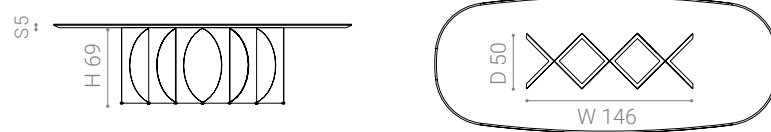

Top suitable for oval base

DOMINO top for oval table

MIKADO top for oval table

ORIGAMI top for oval table

SEGMENTI top for oval table

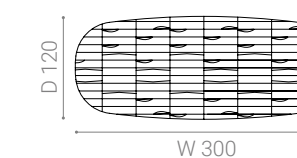
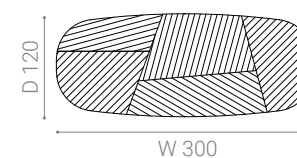
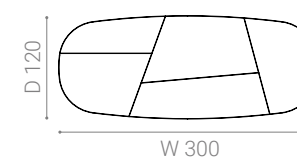
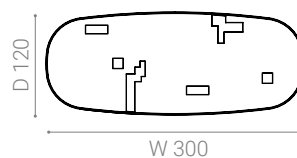
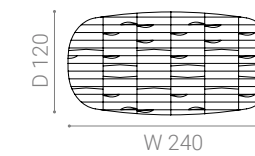
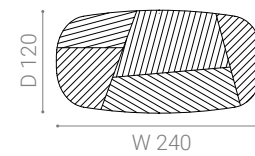
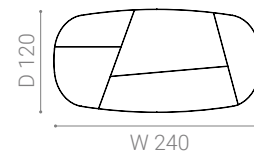
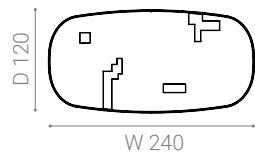

**MAXIME chair**  
Bernhardt & Vella

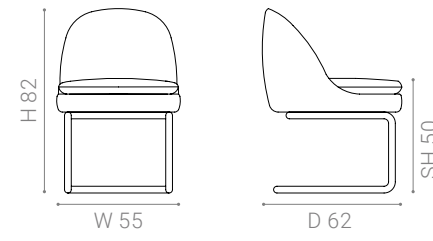

Metal frame, multi-density polyurethane foam padding. Metal base in lacquered and metallic finishing.

Editorial story → P. 110  
Materials & technical drawings → QR Code



**TWILLY chair**  
Bernhardt & Vella

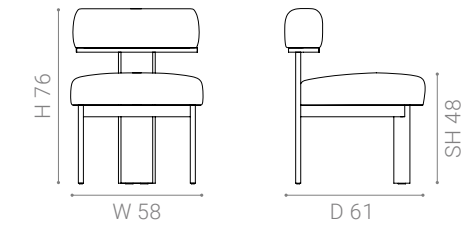

Solid wood frame, lacquered finishing only. Seat and back padding in multi-density polyurethane foam.

Editorial story → P. 104  
Materials & technical drawings → QR Code



**MAXIME SOFT chair**  
Bernhardt & Vella

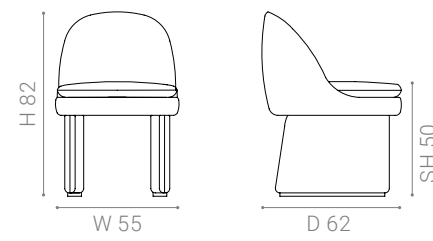

Metal frame, multi-density polyurethane foam padding. Upholstered wooden base.

Editorial story → P. 099  
Materials & technical drawings → QR Code



**TWILLY chair with arms**  
Bernhardt & Vella

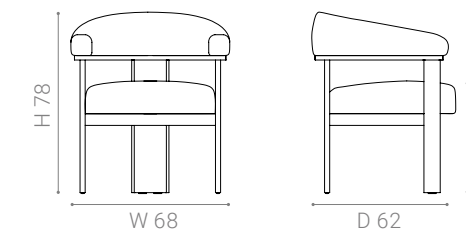

Solid wood frame, lacquered finishing only. Seat and back padding in multi-density polyurethane foam.

Editorial story → P. 092  
Materials & technical drawings → QR Code

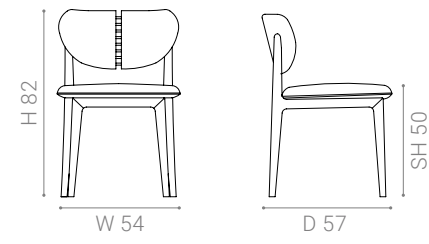

**CLAIRE chair**  
Bernhardt & Vella

Oak solid wood frame, tinted finishing  
with metal details in MO. 508 delabrè copper  
smooth. Seat and back padding  
in multi-density polyurethane foam.

Editorial story → P. 128  
Materials & technical drawings → QR Code



MONOGRAPHY

**ASTORIA bed**  
Bernhardt & Vella

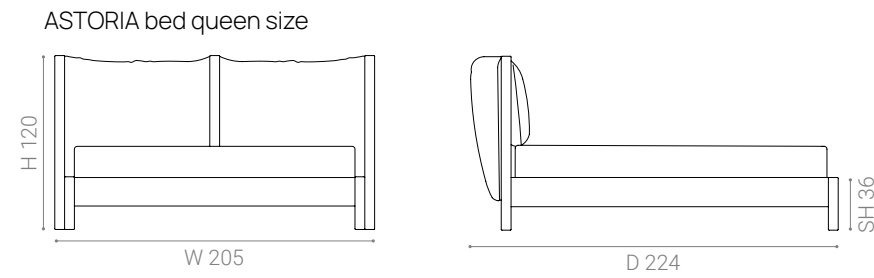
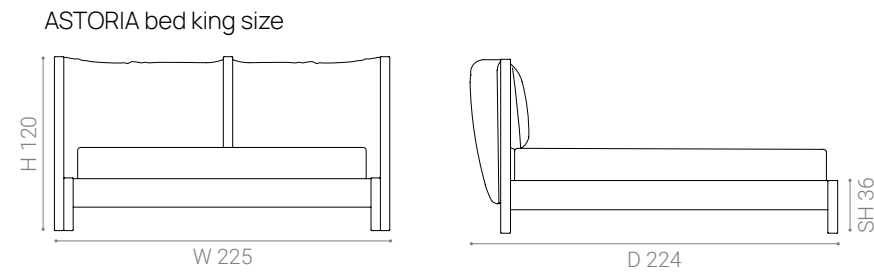

Solid wood and plywood structure.  
Lacquered and metallic finishing.  
Multiple densities polyurethane foam padding. Available in queen and king size.  
Wooden slat included.

Editorial story → P.139  
Materials & technical drawings → QR Code



SENSUAL HOME

**HYDE PARK bed**  
Bernhardt & Vella

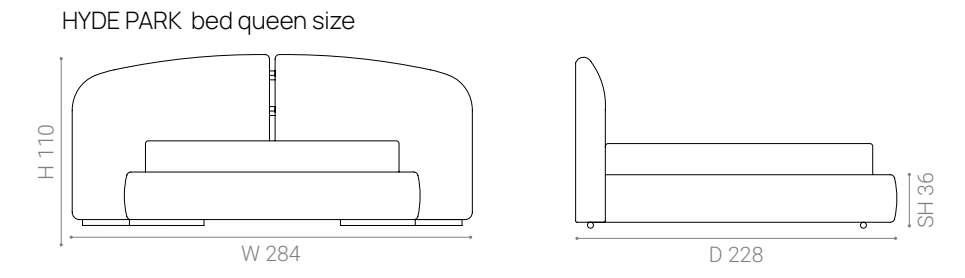
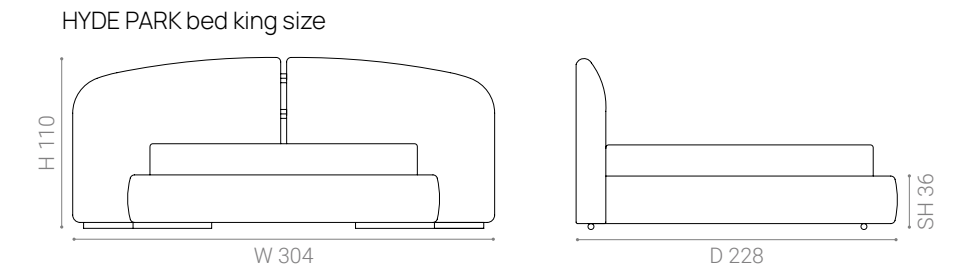

Solid wood and plywood structure, brushed metallic finishing only. Multiple densities polyurethane foam padding. Available in queen and king size. Wooden slat included.

Editorial story → P.143  
Materials & technical drawings → QR Code



**CHELSEA bed**  
Bernhardt & Vella

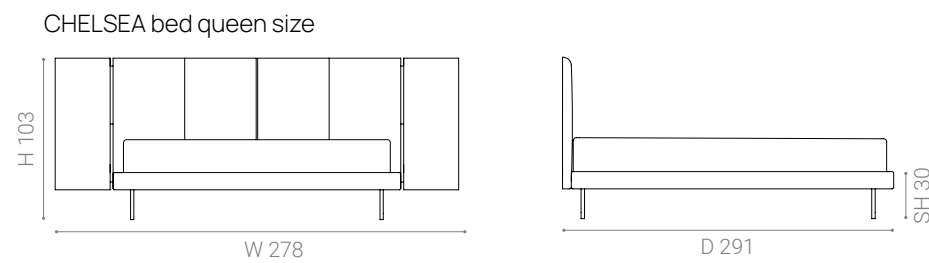
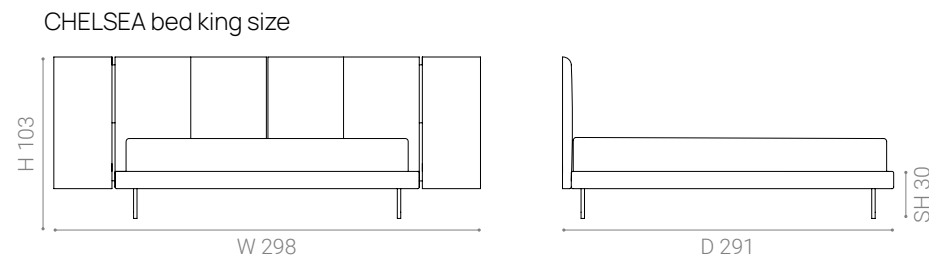

Solid wood frame, metal feet, finishing in MO.508 delabrè copper smooth only. Multiple densities polyurethane foam padding. Available in queen and king size. Wooden slat included.

Editorial story → P.153  
Materials & technical drawings → QR Code



**SOHO bed**  
Bernhardt & Vella

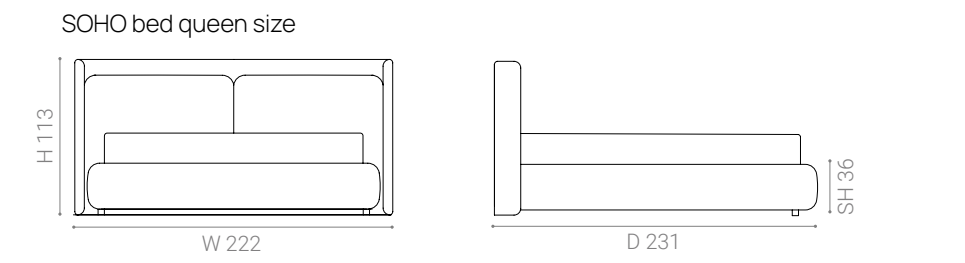
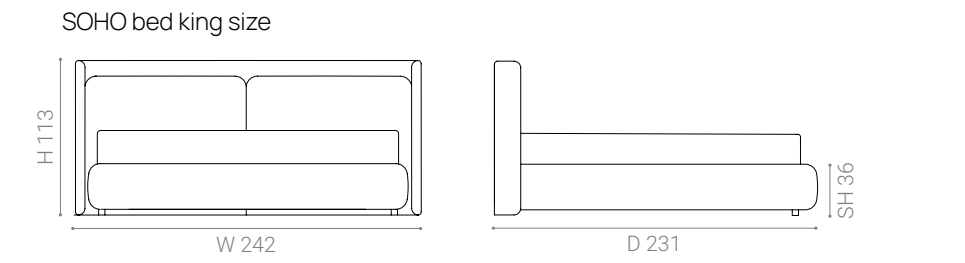

Solid wood and plywood structure. Metal details brushed metallic finishing only. Multiple densities polyurethane foam padding. Available in queen and king size. Wooden slat included.

Editorial story → P.133  
Materials & technical drawings → QR Code



**ANTIBES chest of drawers**  
Bernhardt & Vella

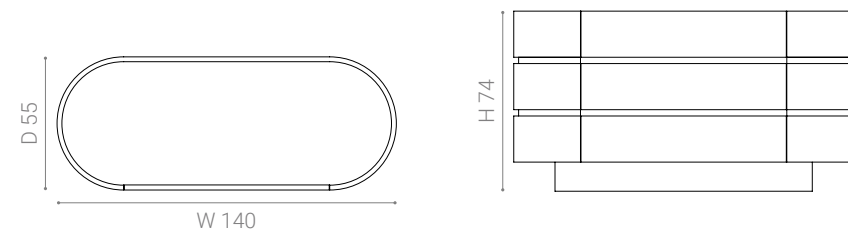

Plywood structure, lacquered and metallic finishing. Top in lacquered wood or marble.

Editorial story → P. 137  
Materials & technical drawings → QR Code



**MAGIC chest of drawers**  
Bernhardt & Vella

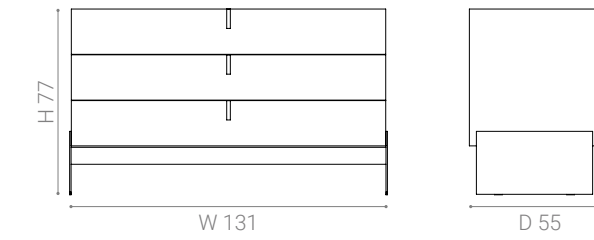
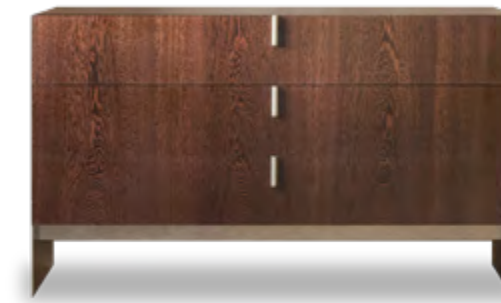

Plywood structure, lacquered and metallic finishing. Top in lacquered wood or marble.

Editorial story → P. 156  
Materials & technical drawings → QR Code



**ANTIBES night table**  
Bernhardt & Vella

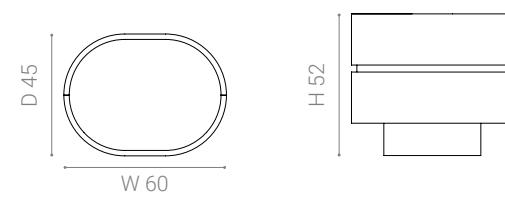

Plywood structure, lacquered and metallic finishing. Top in lacquered wood or marble.

Editorial story → P. 137  
Materials & technical drawings → QR Code



**MAGIC dressing**  
Bernhardt & Vella

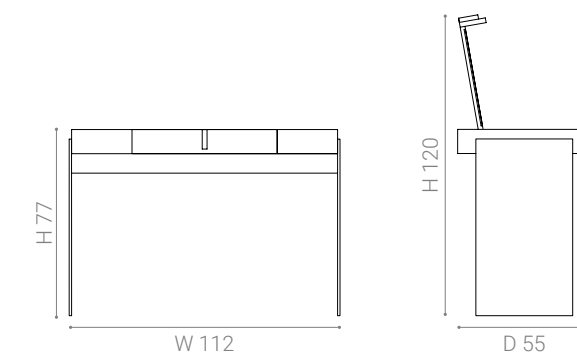

Plywood structure, available in leather or intreccio leather. Metal base in metallic smooth finishing only.

Editorial story → P. 161  
Materials & technical drawings → QR Code





**MAGIC highboy**  
Bernhardt & Vella

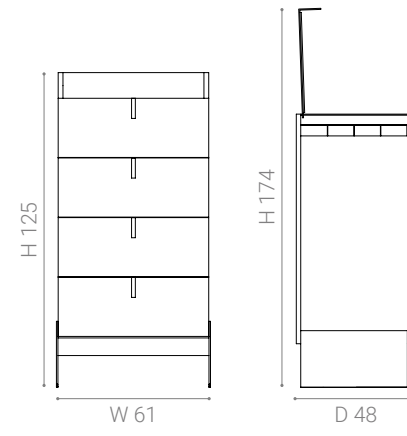

Plywood structure, available in Onyge veneer only. Metal base in metallic smooth finishing only.

Editorial story → P. 162  
Materials & technical drawings → QR Code



**MAGIC night table**  
Bernhardt & Vella

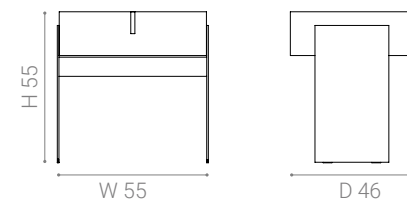

Plywood structure, available in Onyge veneer only. Metal base in metallic smooth finishing only.

Editorial story → P. 159  
Materials & technical drawings → QR Code



**NUAGE sideboard**  
Bernhardt & Vella

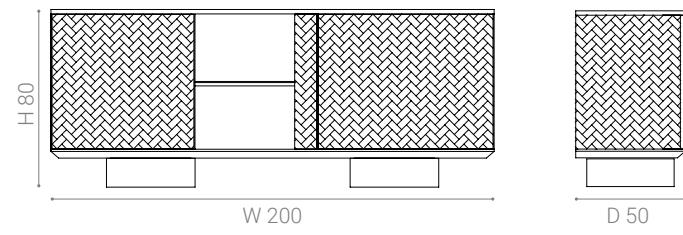

Solid wood and plywood structure.  
Top available in Onyge veneer or marble.  
Front part covered in leather or intreccio leather. Metal details in smooth finishing.

Editorial story → P. 112  
Materials & technical drawings → QR Code



**MEMORIES display cabinet**  
Bernhardt & Vella

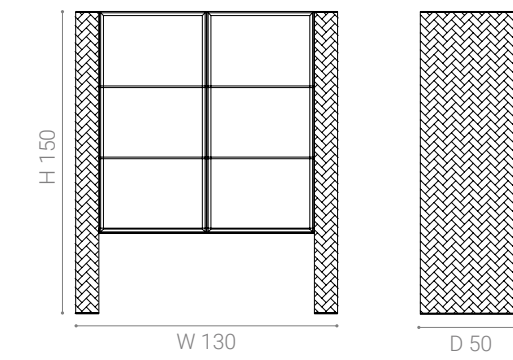
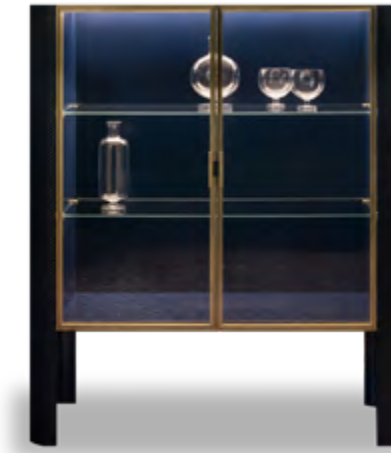

Solid wood and plywood structure.  
Available in leather or intreccio leather on request. Metal frame doors, extrawhite glass. Internally fitted with crystal shelves and led light, in smooth lacquering (matching selected leather).

Editorial story → P. 115  
Materials & technical drawings → QR Code



**NUAGE tv cabinet**  
Bernhardt & Vella

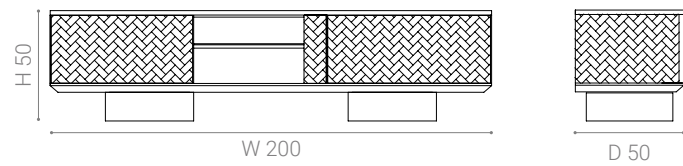

Solid wood and plywood structure.  
Top available in Onyge veneer or marble.  
Front part covered in leather or intreccio leather. Metal details in smooth finishing.

Editorial story → P. 069  
Materials & technical drawings → QR Code



**MONTREAL bookshelf**  
Bernhardt & Vella



Plywood structure, metallic finishing only.  
Embossed bronze glass shelves,  
metal details.

Editorial story → P. 057  
Materials & technical drawings → QR Code

MONTREAL Bookshelf double 150 + 120

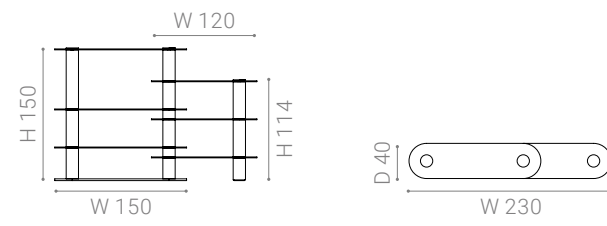

MONTREAL Bookshelf triple 120 + 150 + 120

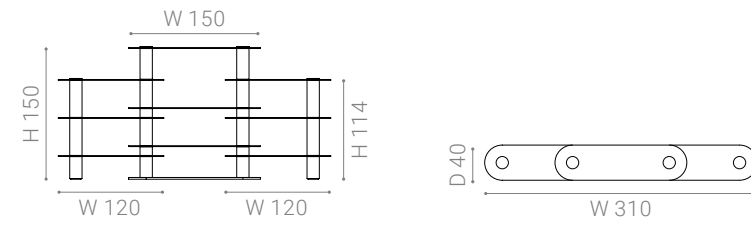

MONTREAL Bookshelf double 150 + 150

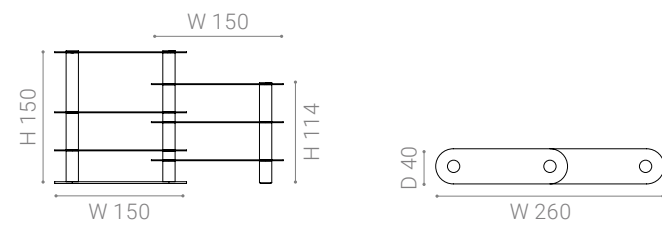

MONTREAL Bookshelf triple 150 + 150 + 150

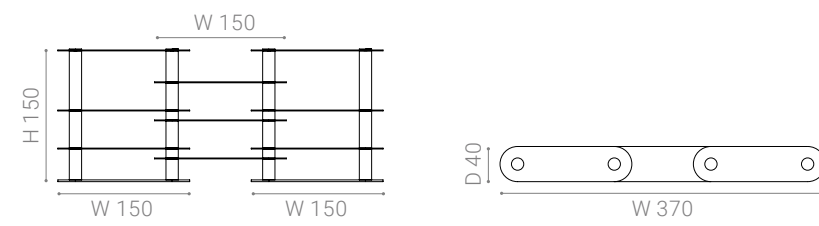

MONTREAL Bookshelf four elements 150 + 150 + 150 + 150

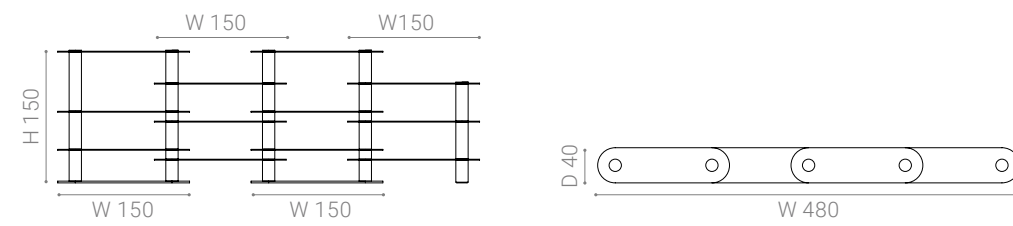

**ALAYA consolle**  
Bernhardt & Vella

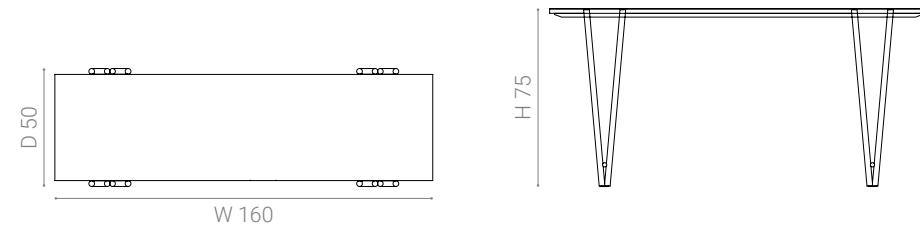

Metal base, finishing in MO.508 delabrè copper smooth, with detail in MO.503 brushed natural brass. Top available in bi color Onyge marquetry or marble only.

Editorial story → P. 012  
Materials & technical drawings → QR Code



**MONTREAL backsofa consolle**  
Bernhardt & Vella

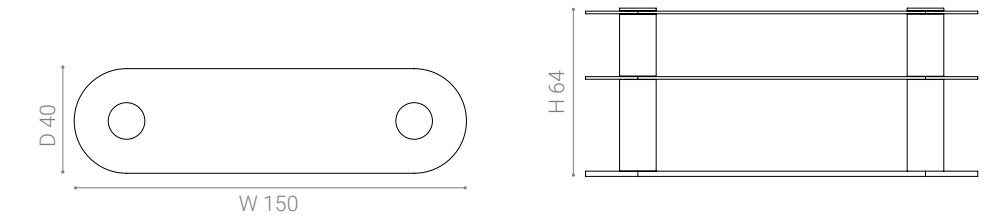

Plywood structure, metallic finishing only. Embossed bronze glass shelves, metal details.

Editorial story → P. 041  
Materials & technical drawings → QR Code



**GALA desk**  
Bernhardt & Vella

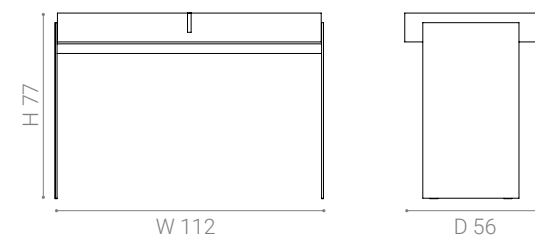

Plywood structure, available in Onyge veneer only. Metal base in metallic smooth finishing only.

Editorial story → P. 059  
Materials & technical drawings → QR Code



**MONTREAL consolle**  
Bernhardt & Vella

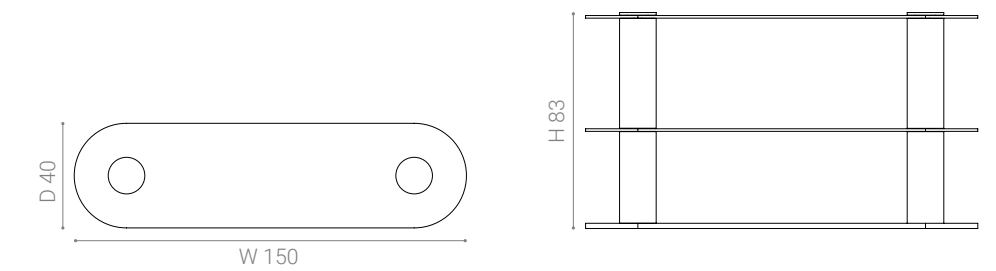

Plywood structure, metallic finishing only. Embossed bronze glass shelves, metal details.

Editorial story → P. 056  
Materials & technical drawings → QR Code



**MEZZALUNA console**  
Bernhardt & Vella

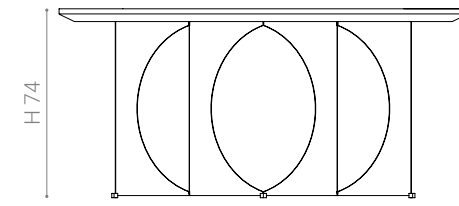
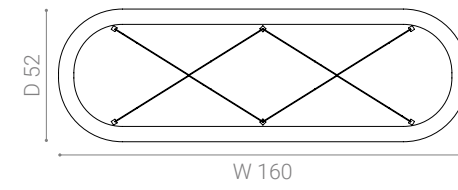

Metal structure, laser cut available  
in lacquered or metallic finishing.  
Top available in Onyge veneer or marble only.

Editorial story → P. 033  
Materials & technical drawings → QR Code



**ALLURE mirror**  
Bernhardt & Vella



ALLURE mirror square

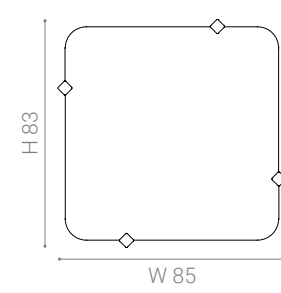

ALLURE mirror round

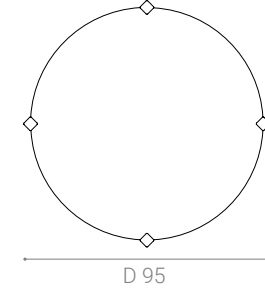

MDF frame with metal details in smooth finishing. Extra-white mirror.

Editorial story → P. 147  
Materials & technical drawings → QR Code



**REFLECT mirror**  
Bernhardt & Vella



REFLECT mirror rectangular

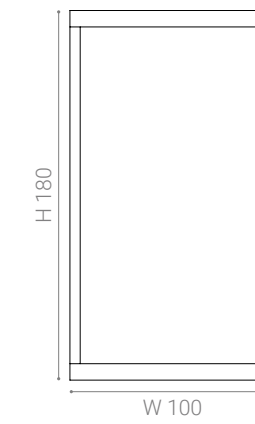

REFLECT mirror square

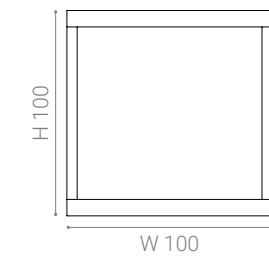

Plywood frame with solid wood decorations, metallic finishing in MO.510 chrome silver brass and MO.511 chrome natural brass. Extra-white mirror.

Editorial story → P. 071  
Materials & technical drawings → QR Code



**HYDE PARK wall decoration**  
Bernhardt & Vella



HYDE PARK wall decoration vertical element

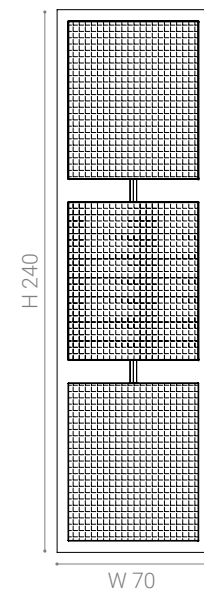

HYDE PARK wall decoration vertical element plus mirror

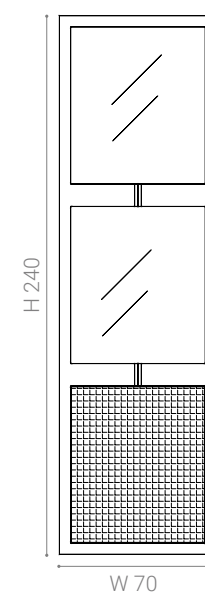

Plywood structure with metal details in smooth finishing. Available in eco-leather back panels with intreccio leather front panels.

Editorial story → P. 117  
Materials & technical drawings → QR Code



**SEGMENTI wall decoration**  
Bernhardt & Vella



SEGMENTI wall decoration square element

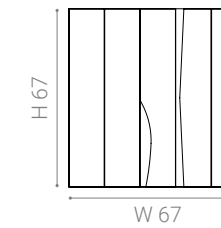

SEGMENTI wall decoration rectangular element

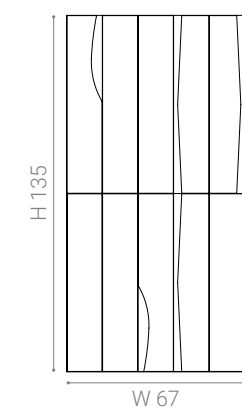

Plywood frame in smooth metallic finishing, with MDF lacquered front decorations.

Editorial story → P. 047  
Materials & technical drawings → QR Code



**NOMAD rug**  
Bernhardt & Vella



NOMAD rug rectangular

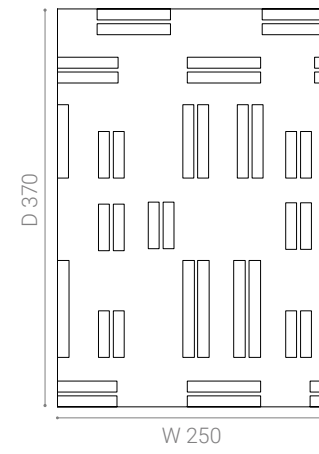

NOMAD rug oval

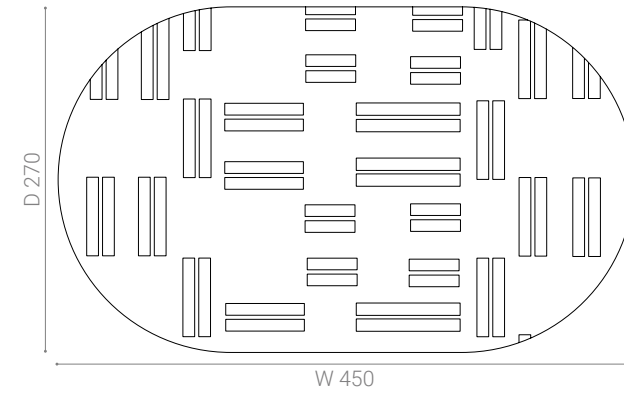

Hand tufted rug. 100% wool with nylon decorations. Available in charcoal grey color.

Editorial story → P.169  
Materials & technical drawings → QR Code



**TAMBOUR rug**  
Bernhardt & Vella

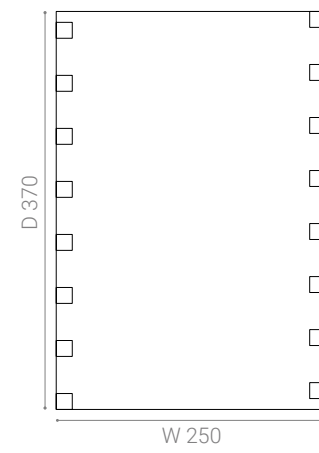

Hand tufted rug with metal inserts in metallic smooth finishing. 100% nylon. Available in grey color.

Editorial story → P.166  
Materials & technical drawings → QR Code



MONOGRAPHY © 2024

Via Crosaron 23, 37053 Cerea, Verona

Tel. +39 0442 80594/80782/329256 - Fax +39 0442 329534

[contact@monography.it](mailto:contact@monography.it)

[@monography.sensualhome](https://www.monography.it)

[monography.it](https://www.monography.it)

Photography by **Francesco Caredda, Stefan Giftthaler**

Graphic design by **MM Company**

Thank you to **Villa Badoer, Condominio San Luca - "Ex Palazzo INA" Verona, Comune di Cerea, Villa Piva 1868**



